



DOCUMENT CONSULTING



LP 3335

INSTRUCTION HANDBOOK

LASER PRINTER B/W

ADVANCED

Contents

| | | |
|---|---|---------|
| 1 | Paper Handling | 1-1 |
| | General Guidelines | 1-2 |
| | Selecting the Right Paper | 1-4 |
| | Paper Type | 1-11 |
| 2 | Using the Operation Panel | 2-1 |
| | General Information | 2-2 |
| | Understanding the Operation Panel | 2-3 |
| | Using the Menu Selection System | 2-8 |
| | Report Print | 2-11 |
| | USB Memory (USB flash memory selection) | 2-16 |
| | Counter (Viewing the counter value) | 2-18 |
| | Paper Settings | 2-19 |
| | Print Settings | 2-28 |
| | Network (Network settings) | 2-40 |
| | Device Common (Selecting/Setting the common device) | 2-45 |
| | Security | 2-57 |
| | Admin (Administrator settings) | 2-65 |
| | Adjust/Maintenance (Adjust/Maintenance selection/setting) | 2-67 |
| 3 | Option | 3-1 |
| | General Information | 3-2 |
| | Expansion Memory Modules | 3-3 |
| | Paper Feeder (PF-100) | 3-5 |
| | CompactFlash (CF) Card | 3-6 |
| | USB Flash Memory | 3-6 |
| 4 | Computer Interface | 4-1 |
| | General Information | 4-2 |
| | USB Interface | 4-2 |
| | Network Interface | 4-3 |
| | Glossary | 5-1 |
| | Index | Index-1 |

Introduction

Regarding Tradenames

PRESCRIBE is a registered trademark of Kyocera Corporation. KPDL is trademark of Kyocera Corporation. Hewlett-Packard, PCL, and PJI are registered trademarks of Hewlett-Packard Company. Centronics is a trade name of Centronics Data Computer Inc. Adobe, Acrobat, Flash, and PostScript are registered trademarks of Adobe Systems Incorporated. Macintosh and Bonjour are registered trademarks of Apple Computer, Inc. Microsoft and Windows are registered trademarks of Microsoft Corporation in the U.S.A. and/or other countries. Microsoft Windows Server, Windows XP and Windows Vista are trademarks of Microsoft Corporation. PowerPC is a trademark of International Business Machines Corporation. CompactFlash is a trademark of SanDisk Corporation. ENERGY STAR is a U.S. registered mark. All other brand and product names are registered trademarks or trademarks of their respective companies.

This product was developed using the Tornado™ Real Time Operating System and Tools from Wind River Systems.

This product contains UFST™ and MicroType® from Monotype Imaging Inc.

About the Advanced Operation Guide

This guide has the following chapters:

1 Paper Handling

This chapter explains how choose, handle and load paper.

2 Using the Operation Panel

This chapter explains how to use the operation panel to configure the printer.

3 Option

This chapter explains the options for this printer.

4 Computer Interface

This chapter explains the possible connections between the printer and your computer.

Glossary

A Glossary of terms used is provided here.

Conventions in This Guide

This manual uses the following conventions.

| Convention | Description | Example |
|------------------------|--|--|
| Italic Typeface | Used to emphasize a key word, phrase or reference to additional information. | Refer to <i>Configuration Tool</i> on page 3-9. |
| Bold | Used to denote buttons on the software. | To start printing, click OK . |
| Bracket Bold | Used to denote operation panel keys. | Printing resumes when [GO] is pressed. |
| Note | Used to provide additional or useful information about a function or feature. |  Note Do not remove the toner container from the carton until you are ready to install it in the printer. |
| Important | Used to provide important information. | IMPORTANT Take care not to touch the transfer roller (black) during cleaning. |
| Caution | Cautions are statements that suggest mechanical damage as a result of an action. | CAUTION When pulling the paper, pull it gently so as not to tear it. Torn pieces of paper are difficult to remove and may be easily overlooked, deterring the paper jam recovery. |
| Warning | Used to alert users to the possibility of personal injury. | WARNING If you ship the printer, remove and pack the developer unit and drum unit in a plastic bag and ship them separately from the printer. |

1 Paper Handling

This chapter explains paper specifications for this printer.

| | |
|----------------------------------|-------------|
| General Guidelines | 1-2 |
| Selecting the Right Paper | 1-4 |
| Paper Type | 1-11 |

General Guidelines

The machine is designed to print on standard copier paper, but it can also accept a variety of other types of paper within the limits specified below.



Note The manufacturer assumes no liability for problems that occur when paper not satisfying these requirements is used.

Selection of the right paper is important. Using the wrong paper can result in paper jams, curling, poor print quality, and paper waste, and in extreme cases can damage the machine. The guidelines given below will increase the productivity of your office by ensuring efficient, trouble-free printing and reducing wear and tear on the machine.

Paper Availability

Most types of paper are compatible with a variety of machines. Paper intended for xerographic copiers can also be used with the machine.

There are three general grades of paper: economy, standard, and premium. The most significant difference between grades is the ease with which they pass through the machine. This is affected by the smoothness, size, and moisture content of the paper, and the way in which the paper is cut. The higher the grade of paper you use, the less risk there will be of paper jams and other problems, and the higher the level of quality your printed output will reflect.

Differences between paper from different suppliers can also affect the machine's performance. A high-quality printer cannot produce high-quality results when the wrong paper is used. Low-priced paper is not economical in the long run if it causes printing problems.

Paper in each grade is available in a range of basis weights (defined later). The traditional standard weights are 60 to 120 g/m² (16 to 31.9 lb).

Paper Specifications

The following table summarizes the basic paper specifications. Details are given on the following pages:

| Item | Specifications |
|-----------------------|---|
| Weight | Cassette: 60 to 120 g/m ² (16 to 31.9 lb/ream) MP tray: 60 to 220 g/m ² (16 to 58.5 lb/ream) |
| Thickness | 0.086 to 0.110mm (3.4 to 4.3 mils) |
| Dimensional Accuracy | ±0.7 mm (±0.0276 inches) |
| Squareness of Corners | 90±0.2° |
| Moisture Content | 4 to 6% |
| Direction of Grain | Long grain |
| Pulp Content | 80% or more |

Minimum and Maximum Paper Sizes

The minimum and maximum paper sizes are as follows. For the paper smaller than JIS B6, postcards, and envelopes, the MP tray must be used.

Paper cassette

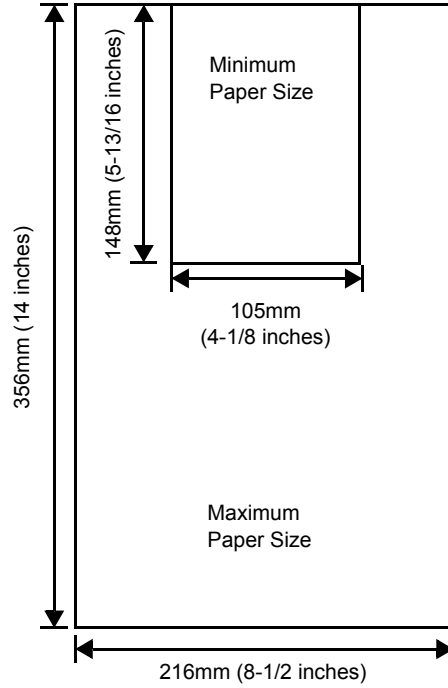

MP tray

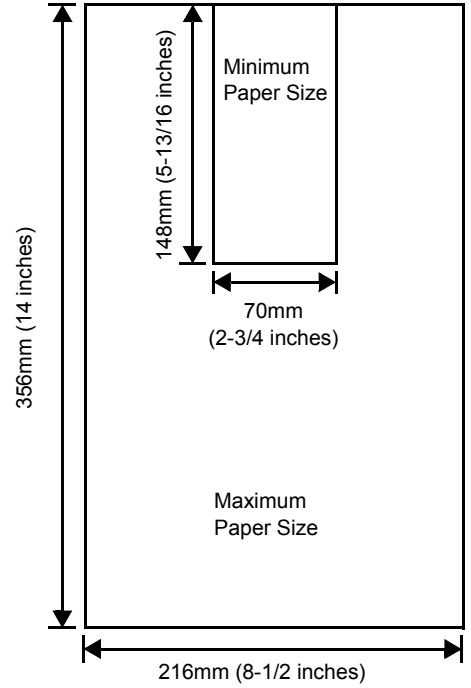

Note The minimum paper size of the optional paper feeder (PF-100) is 148 x 210 mm (5-13/16 x 8-5/16 inches).

Selecting the Right Paper

This section describes the guidelines for selecting paper.

Condition

Avoid using paper that is bent at the edges, curled, dirty, torn, embossed, or contaminated with lint, clay, or paper shreds.

Use of paper in these conditions can lead to illegible printing and paper jams, and can shorten the life of the machine. In particular, avoid using paper with a surface coating or other surface treatment. Paper should have as smooth and even a surface as possible.

Composition

Do not use paper that has been surface-treated and contains plastic or carbon. The heat of fusing can cause such paper to give off harmful fumes.

Bond paper should contain at least 80% pulp. Not more than 20% of the total paper content should consist of cotton or other fibers.

Paper Sizes

Cassettes and the MP Tray are available for the paper sizes shown below. The dimensional tolerances are $\pm 0.7\text{mm}$ for the length and width. The angle at the corners must be $90^\circ \pm 0.2^\circ$.

MP Tray:

Envelope Monarch, Envelope #10, Envelope #9, Envelope #6, Envelope C5, Envelope DL, Legal, Letter, Statement, Oficio II, Executive, ISO A4, ISO A5, ISO A6, Folio, ISO B5, JIS B5, JIS B6, Hagaki, Ofuku-Hagaki, Youkei 2, Youkei 4, 16 kai, Custom (70 × 148 to 216 × 356mm (2-13/16 × 5-13/16 to 8-1/2 × 14 inches))



Note If the length of custom paper is larger than 297mm (11-11/16 inches), the printer can be specified ISO A4, Oficio II, Folio, and Legal as the standard paper size.

Cassette:

Legal, Letter, Statement (only for machine's paper cassette), Oficio II, Executive, ISO A4, ISO A5, A6 (only for machine's paper cassette), Folio, ISO B5, JIS B5, Envelope C5, 16 kai, Custom (Paper Cassette: 105 × 148 to 216 × 356mm (4-1/8 × 5-13/16 to 8-1/2 × 14 inches), Paper Feeder: 148 × 210 to 216 × 356mm (5-13/16 × 8-5/16 to 8-1/2 × 14 inches))



Note If the length of custom paper is larger than 297mm (11-11/16 inches), the printer can be specified ISO A4, Oficio II, Folio, and Legal as the standard paper size.

Smoothness

The paper should have a smooth, uncoated surface. Paper with a rough or sandy surface can cause blank spaces in the printed output. Paper that is too smooth can cause multiple feeding and fogging problems. (Fogging is a gray background effect.)

Basis Weight

Basis weight is the weight of paper expressed in grams per square meter (g/m²). Paper that is too heavy or too light may cause feed errors or paper jams as well as premature wear of the product. Uneven weight of paper, namely uneven paper thickness may cause multiple-sheet feeding or print quality problems such as blurring because of poor toner fusing.

The recommended basis weight is between 60 and 120g/m² (16 to 31.9 lib/ream) for the cassette and between 60 and 220g/m² (16 to 59 lib/ream) for the MP tray.

Paper Weight Equivalence Table

The paper weight is listed in pounds (lb) and metric grams per square meter (g/m²). The shaded part indicates the standard weight.

| U. S. Bond Weight (lb) | Europe Metric Weight (g/m ²) |
|------------------------|--|
| 16 | 60 |
| 17 | 64 |
| 20 | 75 |
| 21 | 80 |
| 22 | 81 |
| 24 | 90 |
| 27 | 100 |
| 28 | 105 |
| 32 | 120 |
| 34 | 128 |
| 36 | 135 |
| 39 | 148 |
| 42 | 157 |
| 43 | 163 |
| 47 | 176 |
| 53 | 199 |

Thickness

The paper used with the machine should be neither extremely thick nor extremely thin. If you are having problems with paper jams, multiple feeds, and faint printing, the paper you are using may be too thin. If you are having problems with paper jams and blurred printing the paper may be too thick. The correct thickness is 0.086 to 0.110mm (3.4 to 4.3 mils).

Moisture Content

Moisture content is defined as the percent ratio of moisture to the dry mass of the paper. Moisture can affect the paper's appearance, feed ability, curl, electrostatic properties, and toner fusing characteristics.

The moisture content of the paper varies with the relative humidity in the room. When the relative humidity is high and the paper absorbs moisture, the paper edges expand, becoming wavy in appearance. When the relative humidity is low and the paper loses moisture, the edges shrink and tighten, and print contrast may suffer.

Wavy or tight edges can cause jams and alignment anomalies. The moisture content of the paper should be 4 to 6%.

To ensure correct moisture content, it is important to store the paper in a controlled environment. Some tips on moisture control are:

- Store paper in a cool, dry location.
- Keep the paper in its wrapping as long as possible. Re-wrap paper that is not in use.
- Store paper in its original carton. Place a pallet etc. under the carton to separate it from the floor.
- After removing paper from storage, let it stand in the same room as the machine for 48 hours before use.
- Avoid leaving paper where it is exposed to heat, sunlight, or damp.

Paper Grain

When paper is manufactured, it is cut into sheets with the grain running parallel to the length (long grain) or parallel to the width (short grain). Short grain paper can cause feeding problems in the machine. All paper used in the machine should be long grain.

Other Paper Properties

Porosity: Indicates the density of paper fiber.

Stiffness: Limp paper may buckle in the machine, resulting in paper jams.

Curl: Most paper naturally tends to curl one way if left unpacked. When paper passes through the fixing unit, it curls upward a little. To produce flat printouts, load the paper so that the upward pressure from the machine can correct their curling.

Electrostatic discharge: During the printing process the paper is electrostatically charged to attract the toner. The paper must be able to release this charge so that printed sheets do not cling together in the Output Tray.

Whiteness: The contrast of the printed page depends on the whiteness of the paper. Whiter paper provides a sharper, brighter appearance.

Quality control: Uneven sheet size, corners that are not square, ragged edges, welded (uncut) sheets, and crushed edges and corners can cause the machine to malfunction in various ways. A quality paper supplier should take considerable care to ensure that these problems do not occur.

Packaging: Paper should be packed in a sturdy carton to protect it from damage during transport. Quality paper obtained from a reputable supplier is usually correctly packaged.

Special Paper

The following types of special paper can be used:

| Paper type to be used | Paper type to be selected |
|---|---------------------------|
| Thin paper (60 to 64 g/m ²) | Vellum |
| Thick paper (90 to 220 g/m ²) | Thick |
| Colored paper | Color |
| Recycled paper | Recycled |
| Overhead projector transparencies | Transparency |
| Cardstock | Cardstock |
| Envelopes | Envelope |
| Label | Labels |

Use paper that is sold specifically for use with copiers or printers (heat-fusing type). When using transparencies, labels, envelopes, cardstock, or thick paper, feed the paper from the MP Tray.

Since the composition and quality of special paper vary considerably, special paper is more likely than white bond paper to give trouble during printing. No liability will be assumed if moisture and so forth given off during printing on special paper causes harm to the machine or operator.



Note Before purchasing any type of special paper, test a sample on the machine and check that printing quality is satisfactory.

Half speed mode is automatically engaged depending on **Media types**, including **Labels**, **Rough**, and **Thick**.

Transparency

This printer is available for monochrome printing on transparencies. Transparencies must be fed to the MP Tray. One transparency can be loaded at a time.

Transparencies must be able to withstand the heat of fusing during the printing process.

Transparencies must be placed on the MP tray with the long edge towards the printer.

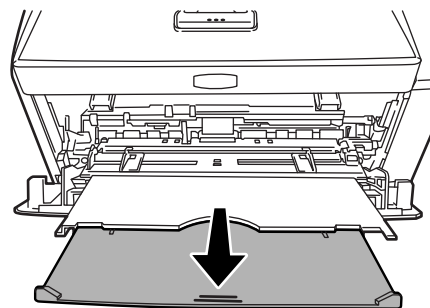

When unloading transparencies (e.g., for clearing jams), hold them carefully by the edges to avoid leaving fingerprints on them.

Labels

Labels must be fed to the MP tray. One label can be loaded at a time.

The basic rule for printing on adhesive labels is that the adhesive must never come into contact with any part of the machine. Adhesive paper sticking to the drum or rollers will damage the machine.

Label paper has a structure comprising of three layers, as shown in the diagram. The top sheet is printed on. The adhesive layer consists of pressure-sensitive adhesives. The carrier sheet (also called the linear or backing sheet) holds the labels until used. Due to the complexity of its composition, adhesive-backed label paper is particularly likely to give printing problems.

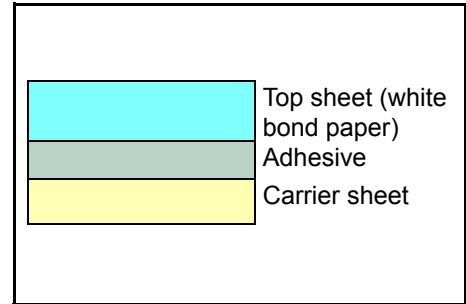

Adhesive label paper must be entirely covered by its top sheet, with no spaces between the individual labels. Labels with spaces in between are liable to peel off, causing serious paper jam problems.

Some label paper is manufactured with an extra margin of top sheet around the edge. Do not remove the extra top sheet from the carrier sheet until after printing is finished.

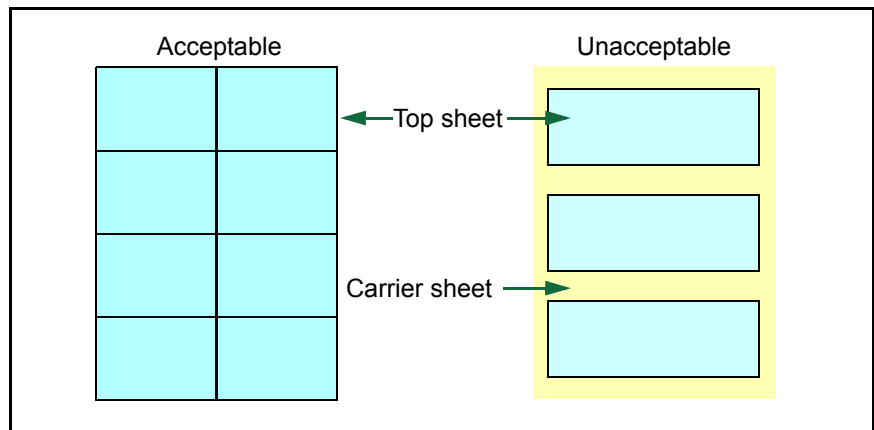

The table below lists the specifications for adhesive label paper.

| Item | Specification |
|------------------------|--|
| Weight of top sheet | 44 to 74 g/m ² (12 to 20 lb/ream) |
| Composite weight | 104 to 151 g/m ² (28 to 40 lb/ream) |
| Thickness of top sheet | 0.086 to 0.107 mm (3.9 to 4.2 mils) |
| Composite thickness | 0.115 to 0.145 mm (4.5 to 5.7 mils) |
| Moisture content | 4 to 6 % (composite) |

Postcards

Up to 10 postcards can be loaded at a time. Fan the stack of postcards and align the edges before loading them in the MP tray. Make sure the postcards you are going to set are not curled. Feeding curled postcards may cause paper jams.

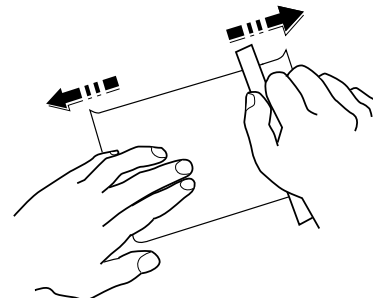

Some postcards have rough edges on the back (those are created when the paper is cut). In this case, put the postcards on a flat place and rub the edges with, for example, a ruler to smooth them.

Envelopes

Up to 5 envelopes can be loaded at a time. Envelopes should be fed in the face-up position, right edge first.

Since the composition of an envelope is more complex than that of ordinary paper, it is not always possible to ensure consistent printing quality over the entire envelope surface.

Normally, envelopes have a diagonal grain direction. Refer to *Paper Grain* on page 1-6. This direction can easily cause wrinkles and creases when envelopes pass through the printer. Before purchasing envelopes, make a test print to check whether the printer accepts the envelope.

- Do not use envelopes that have an encapsulated liquid adhesive.
- Avoid a long printing session for envelopes only. Extended envelope printing can cause premature printer wear.
- If jams occur, try setting less envelopes on the MP tray.
- To avoid jams caused by curled envelopes, stack no more than 10 printed envelopes on the output tray.

Thick Paper

Fan the stack of paper and align the edges before loading them in the MP tray. Some types of paper have rough edges on the back (those are created when the paper is cut). In this case, put the paper on a flat place and rub the edges once or twice with, for example, a ruler to smooth them. Feeding rough edged paper may cause paper jams.



Note If the paper jams even after you smooth it out, load the paper in the MP tray with the leading edge raised up a few millimeters as shown in the illustration.

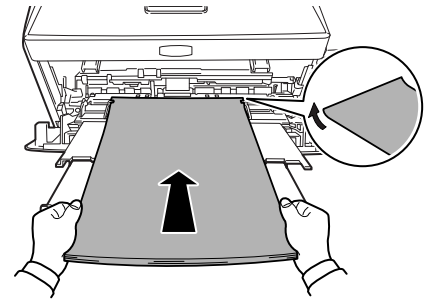

Colored Paper

Colored paper should satisfy the same conditions as white bond paper. Refer to *Paper Specifications* on page 1-2. In addition, the pigments used in the paper must be able to withstand the heat of fusing during the printing process (up to 200 °C or 392 °F).

Preprinted Paper

Preprinted paper should satisfy the same conditions as white bond paper. Refer to *Paper Specifications* on page 1-2. The preprinted ink must be able to withstand the heat of fusing during the printing process, and must not be affected by silicone oil.

Do not use paper with any kind of surface treatment, such as the type of paper commonly used for calendars.

Recycled Paper

Select recycled paper that meets the same specifications as the white bond paper except for whiteness. Refer to *Paper Specifications* on page 1-2.



Note Before purchasing recycled paper, test a sample on the machine and check that the printing quality is satisfactory.

Paper Type

The printer is capable of printing under the optimum setting for the type of paper being used.

Setting the paper type for the paper source from the printer's operation panel will cause the printer to automatically select the paper source and print in the mode best suited to that type of paper.

A different paper type setting can be made for each paper source including the MP tray. Not only can preset paper types be selected, but it is also possible for you to define and select customized paper types. Refer to *Type Adjust (Creating custom paper type)* on page 2-25. The following types of paper can be used.

| Paper Type | Paper source | | |
|------------------|--------------|----------------|-------------|
| | MP tray | Paper Cassette | Duplex path |
| Plain | Yes | Yes | Yes |
| Transparency | Yes | No | No |
| Preprinted | Yes | Yes | Yes |
| Labels | Yes | No | No |
| Bond | Yes | Yes | Yes |
| Recycled | Yes | Yes | Yes |
| Vellum | Yes | No | No |
| Rough | Yes | Yes | Yes |
| Letterhead | Yes | Yes | No |
| Color | Yes | Yes | Yes |
| Prepunched | Yes | Yes | Yes |
| Envelope | Yes | No | No |
| Cardstock | Yes | No | No |
| Thick | Yes | No | No |
| High quality | Yes | Yes | Yes |
| Custom 1 (to 8)* | Yes | Yes | Yes |

Yes: Can be stored No: Cannot be stored

- *. This is a paper type defined and registered by the user. Up to eight types of user settings may be defined. User can also enable or disable the duplex path when using Custom. For more information, refer to *Type Adjust (Creating custom paper type)* on page 2-25.

2 Using the Operation Panel

This chapter contains explanations on the following topics:

| | |
|--|-------------|
| General Information | 2-2 |
| Understanding the Operation Panel | 2-3 |
| Using the Menu Selection System | 2-8 |
| Report Print | 2-11 |
| USB Memory (USB flash memory selection) | 2-16 |
| Counter (Viewing the counter value) | 2-18 |
| Paper Settings | 2-19 |
| Print Settings | 2-28 |
| Network (Network settings) | 2-40 |
| Device Common (Selecting/Setting the common device) | 2-45 |
| Security | 2-57 |
| Admin (Administrator settings) | 2-65 |
| Adjust/Maintenance (Adjust/Maintenance selection/setting) | 2-67 |

General Information

This chapter provides the information you need to configure the printer. In general you need to use the operation panel only to make default settings. You can make most changes to the printer settings using the printer driver through the application software.



Note Changes to printer settings made using a software application override changes made using the operation panel.

You can also access the printer's various settings from a remote location, by using the control panel, the printer driver or other utilities such as the Status Monitor Utility. Other printer utilities can be installed using the CD-ROM supplied with the printer.

The chapter describes the operation panel in detail, including its menus and the procedures for changing various printer settings.

Understanding the Operation Panel

The operation panel on the top of the printer has a 2-line by 21-character liquid crystal display (LCD), eight keys, and three indicators (LED).

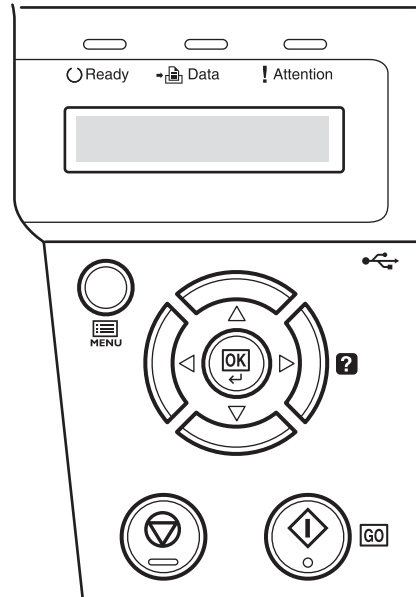

Messages that appear on the display and functions of indicators and keys are explained in this chapter.

Message Display

The message display on the operation panel shows:

- Status information, the ten messages listed below which are displayed during normal operation.
- Error codes, when the printer requires the operator's attention; as explained in the *Operation Guide*.

Status Information

| Message | Meaning |
|-------------------------------|--|
| Self test | The printer is performing self-diagnostics after power-up. |
| Please wait | The printer is warming up and is not ready. When the printer is switched on for the first time, this message will take several minutes. |
| Please wait (Adding toner) | Toner is currently being replenished. This message may be displayed during continuous printing of a large volume of pages which require a large amount of toner such as with photographs, etc. |
| Ready | The printer is ready to print. |
| Processing | The printer is receiving data to print. This is also shown when the printer is reading a CF card, USB flash memory or RAM disk. |
| Sleeping | The printer is in Auto Sleep. The printer wakes from Auto Sleep whenever a print job is received. The printer then warms up and goes on-line. For details on Auto Sleep, refer to Sleep Timer (Sleep timer timeout time) on page 2-54 . |
| Canceling data | Jobs inside the printer are being canceled. To cancel a job, refer to Canceling a Printing Job on page 2-6 . |

Error Codes

Refer to the *Troubleshooting* section in the *Operation Guide*.

Indicators in Message Display

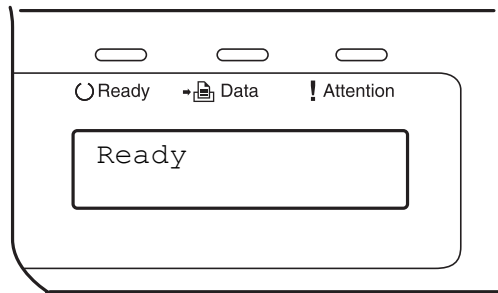

Ready, Data, and Attention Indicators

The following indicators light during normal operation and whenever the printer needs attention. Depending on the status of lighting, each indicator has the following meaning:

| Indicator | Description |
|-------------|---|
| ○ Ready | <p>Flashing. Indicates an error that you can resolve. For details, refer to the <i>Troubleshooting</i> section in the <i>Operation Guide</i>.</p> <p>On. Indicates that the printer is ready. The printer prints the data it receives.</p> <p>Off. [Cancel] was pressed during <i>Ready</i> is displayed. Data can be received but will not be printed. To resume printing, press [Cancel] again.</p> <p>Printing is canceling.</p> <p>Also, indicates when paper jam occurred, toner has run out, cover is open, and so on. For details, refer to the <i>Troubleshooting</i> section in the <i>Operation Guide</i>.</p> |
| → Data | <p>Flashing. Indicates that a data is being received.</p> <p>On. Indicates either that data received is being processed before printing starts, or that data received is being written to or read from a CompactFlash (CF) card, RAM disk, or USB flash memory.</p> |
| ! Attention | <p>Flashing. Indicates that the printer is ready to print when <i>Please wait</i> is displayed. Also indicates that the corresponding paper cassette is not installed.</p> <p>Indicates that the printer requires maintenance such as adding paper, cleaning the printer, preparing the toner container, formatting of CF card.</p> <p>On. Indicates when paper jam occurred, toner has run out, cover is open, and so on. If the message includes <i>Press GO</i>, press [GO] to resume printing. For details, refer to the <i>Troubleshooting</i> section in the <i>Operation Guide</i>.</p> <p>The ID or Password entered for the Security, Administrator, or Job Accounting function is not correct. Check the ID or Password, and enter the correct ID or password.</p> |

Keys

The operation panel keys are used to configure the printer operation. Note that certain keys have a secondary function.

GO Key



Use this key to:

- Recover from certain errors.
- Recover from Auto Sleep mode.

Cancel Key



This key is used to:

- Cancel a printing job.
- Stop the alarm sound.
- Reset numeric values or cancel a setting procedure while using menu system.

Canceling a Printing Job

- 1** While the printer displays `Processing`, press **[Cancel]**.

`Print Cancel?` appears on the message display followed by the job name currently in progress.

- 2** Press \triangle or ∇ to display the desired job and **[OK]**.

`Canceling data` appears on the message display and printing stops after the current page is printed.

MENU Key



[MENU] lets you enter the menu system to change the setup and printing environment of the printer.

Pressing this key during a menu selection will terminate the selection and return the printer to the normal operation.

Cursor Keys

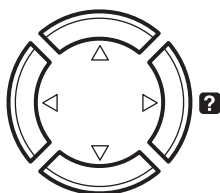

The four cursor keys are used in the menu system to access an item or enter numeric values. Use \triangle and ∇ to change menus, and \triangleleft and \triangleright to move to the sub menu.

The cursor key with the question mark () may be pressed when the paper jam message has appeared on the message display. A help message will then appear to facilitate jam clearing in the location.

When `Use alternative?` is shown in the message display, use the \triangle and ∇ key to select the paper source.

OK Key



This key is used to:

- Finalize settings of numeric values and other selections.
- Set the paper source when `Use alternative?` is shown in the message display.

Using the Menu Selection System

Menu Selection System

This section explains how to use the menu selection system. **[MENU]** on the operation panel allows you to use the menu to configure the printer settings to your specific needs. Settings can be made when *Ready*, *Please wait*, *Sleeping* or *Processing* is on the printer message display.



Note Settings that are received from application software and the printer driver will take priority over settings made in the operation panel.

Entering the Mode Selection Menu

Press **[MENU]** when *Ready*, *Please wait*, *Sleeping* or *Processing* is indicated on the printer message display.

The mode selection menu is displayed.

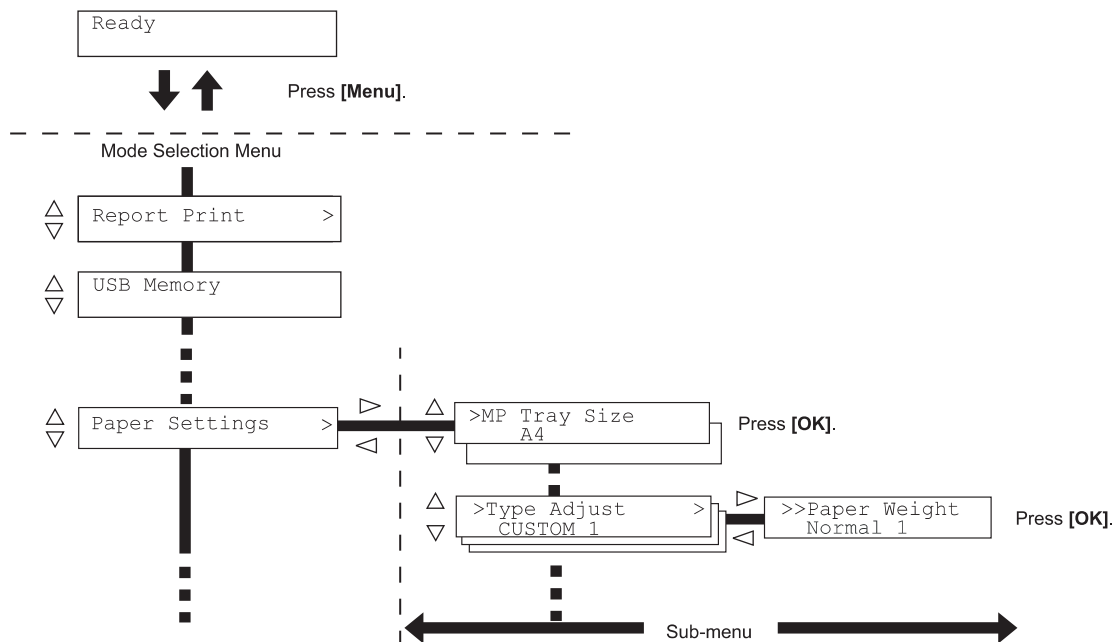

Selecting a Menu

The mode selection menu is hierarchical. Press \triangle or ∇ to display the desired menu.

If the selected menu has a sub-menu, > is displayed after the menu.

Press \triangleright to move to the sub-menu or \triangleleft to go back.

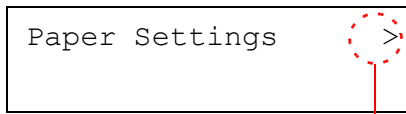

Indicates that there is a sub-menu

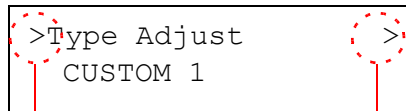

Indicates that this is the sub-menu

Indicates that there is another sub-menu

> is displayed before the sub-menu.

Press \triangleright to move to another sub-menu or \triangleleft to go back.

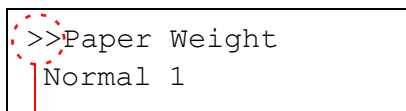

Indicates that this is the second sub-menu

>> is displayed before the second sub-menu.

Setting a Menu

Select the desired menu and press **[OK]** to set or change the configuration.

Press \triangle or ∇ to display the desired item and **[OK]** to finalize the value or selections set.

Cancelling Menu Selection

If you press **[MENU]** when a menu is selected, the message display returns to *Ready*.

Setting a Mode Selection Menu

This section explains the setting procedures used for each menu item in the mode selection menu.

Report Print >

- 1 While the printer displays *Ready*, *Please wait*, *Sleeping* and *Processing*, press **[MENU]**. The mode selection menu is displayed. (For example : *Report Print*)
- 2 Each time you press Δ or ∇ , the selection changes.
 - Report Print
 - USB Memory
 - Counter
 - Paper Settings
 - Print Settings
 - Network
 - Device Common
 - Security
 - Admin
 - Adjust/Maintenance



Note If you use the mode first selected when the printer is turned on, *Report Print* is displayed. For the second and subsequent times, the last menu option you selected the previous time is displayed.

Report Print

The printer prints the report. Report Print includes the following items:

- Print Menu Map
- Print Status Page
- Print Fonts List
- Print RAM Disk File List
- Print Mem. Card File List

1 Press **[MENU]**.

2 Press Δ or ∇ repeatedly until `Report Print >` appears.

```
Report Print >
```

Note that menus shown in the list may vary depending on which optional units installed in the printer.

Print Menu Map

The printer prints a full list of the menu selection system menu map.

1 Press \triangleright while `Report Print >` is displayed.

2 `>Print Menu Map` appears. In other displays, press Δ or ∇ repeatedly until the map appears.

3 Press **[OK]**. A question mark (?) appears.

```
>Print Menu Map ?
```

4 Press **[OK]**. The message `Processing` appears and the printer prints a Menu Map.

Menu Map Sample

Menu Map Printer

Firmware version

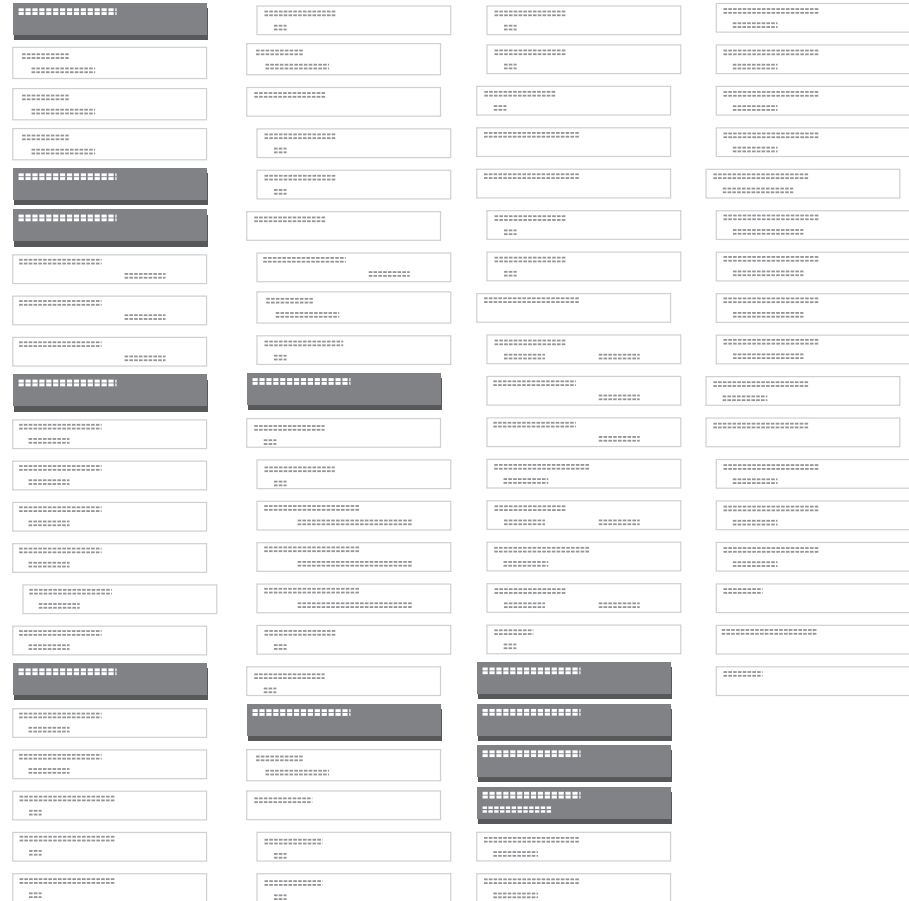

.....

Print Status Page

You can check the printer's current status, including available memory space and option settings by printing a status page.

- 1 Press \triangleright while `Report Print >` is displayed.
- 2 Press \triangle or ∇ repeatedly until `>Print Status Page` appears.
- 3 Press **[OK]**. A question mark (?) appears.
- 4 Press **[OK]** again. The message `Processing` appears and the printer prints a status page.

>Print Status Page ?

For a sample status page and its full description, refer to the next section ***Understanding the Status Page***.

Understanding the Status Page

The numbers in the following diagram refer the items explained below the diagram. The items and values on the status page may vary depending on the printer's firmware version.

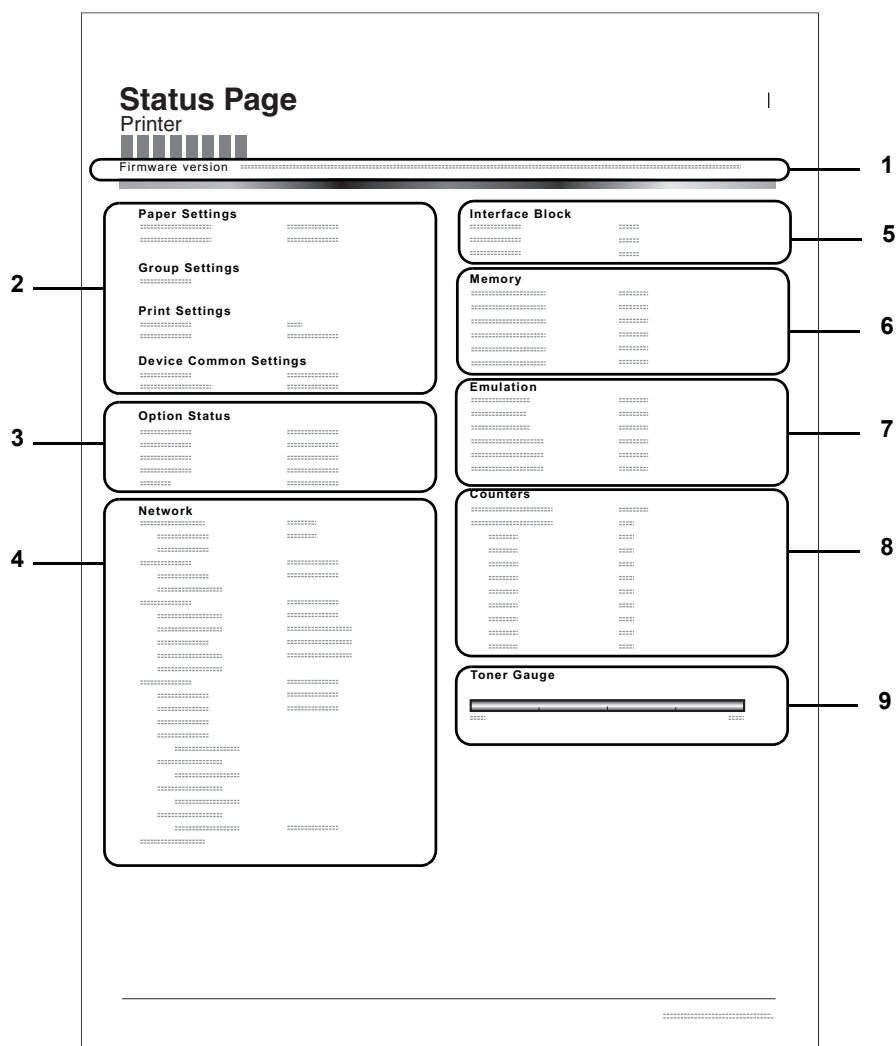

1 Firmware Version

This item shows the version and release date of the printer firmware.

2 Printer Settings Information

This item shows various printer settings for hardware-related items:

- MP tray paper size and type
- Paper cassette size and type
- Sleep time
- Formfeed timeout time

3 Installed Options

This item shows the option installed in the printer:

- Memory card (CompactFlash card)

4 Network Status

This item shows the IP address, subnet mask address, and default gateway address for the network interface card in the printer.

5 Interface Information

This information shows the settings for all interfaces installed in the printer.

6 Memory

This item shows:

- Standard memory in the printer
- Option memory slot status in kilobytes
- Total memory in the printer
- Current status of the RAM disk

7 Emulation

This item shows all available emulations of the printer. The PCL 6 emulation is set as default when the printer is shipped from the factory. The emulations are:

- PCL 6
- KPDL
- Line Printer
- IBM Proprinter
- DIABLO 630
- EPSON LQ-850

8 Page Information

This item shows the page related items:

- Total printed page count
- Total page count of each paper size

9 Consumable Status

This item shows the approximate level of remaining toner. When the value is 100, the toner container is full. The closer to 0, the smaller the amount of remaining toner.

Print Fonts List

To help you decide in selecting a font, you can printout lists of the internal fonts or the optional fonts.

- 1 Press \triangleright while `Report Print >` is displayed.
- 2 Press \triangle or ∇ repeatedly until `>Print Fonts List` appears.
- 3 Press **[OK]**. A question mark (?) appears.
- 4 Press **[OK]** again. The message `Processing` appears and the printer prints a list of fonts with a sample and font ID (number) for each of them.

```
>Print Fonts List ?
```

Print RAM Disk File List

This allows you to print a list of the files on the RAM disk.

IMPORTANT This is displayed when RAM disk mode is enabled.

- 1 Press \triangleright while `Report Print >` is displayed.
- 2 Press \triangle or ∇ repeatedly until `>Print RAM Disk File List` appears.
- 3 Press **[OK]**. A question mark (?) appears.
- 4 Press **[OK]** again. The message `Processing` appears and the printer prints a list of files stored in a RAM disk.

```
>Print RAM Disk  
File List ?
```

Print Mem. Card File List

This allows you to print a list of the files on a CompactFlash (memory) card.

IMPORTANT This message will be displayed when the CompactFlash (CF) card installed in the printer.

- 1 Press \triangleright while `Report Print >` is displayed.
- 2 Press \triangle or ∇ repeatedly until `>Print Mem. Card File List` appears.
- 3 Press **[OK]**. A question mark (?) appears.
- 4 Press **[OK]** again. The message `Processing` appears and the printer prints a list of files stored in a CF card.

```
>Print Memory Card  
File List ?
```

USB Memory (USB flash memory selection)

This specifies the settings for removing the USB flash memory and printing USB flash memory content. The USB Memory menu automatically appears when you install the USB memory.

IMPORTANT This message is displayed only when the USB host block is set to `Unblock`. For more information, refer to **Interface Block (Interface (external device) block setting)** on page 2-58.

The options available in USB flash memory are as follows:

- Print File (Printing a file)
- Copies (Number of copies)
- Paper Source (Selecting the paper feed source)
- Remove Device (Removing the USB flash memory)
- Print File List (Printing a list of the files on a USB flash memory)

1 Press **[MENU]**.

2 Press Δ or ∇ repeatedly until `USB Memory >` appears.

Note that menus shown in the list may vary depending on which optional units installed in the printer.

```
USB Memory >
```

Print File (Printing a file)

You can use this to specify printing for files in the USB flash memory.

1 Press \triangleright while `USB Memory >` is displayed.

2 `>Print File` appears. In other displays, press Δ or ∇ repeatedly until the map appears.

3 Press **[OK]**. A question mark (?) appears.

4 Press **[OK]** again. The folder or file appears.

(For example : `Folder 1`)

Each time you press Δ or ∇ , the next folder or file appears in succession.

To view lower-level folders or files, press \triangleright .

(For example : `Folder 2`)

To view folders or files on still lower levels, press \triangleright .

(For example : `File 3`)

IMPORTANT The `Print File` menu option is only displayed when there is a PDF, TIFF or XPS file in the USB flash memory. Note also that up to 3 levels of folders or files are displayed. It might take some time before the folder or file name appears, depending on the size of the USB flash memory or the number of files.

You can move between the folder levels by pressing Δ and ∇ or \triangleleft and \triangleright .

5 Press **[OK]**. A question mark (?) appears.

(For example : `File 3`)

6 Press **[OK]** again. `Copies` appears.

```
/  
/00:Folder 1
```

```
/00:Folder 1  
/01:Folder 2
```

```
/.../01:Folder 2  
02:File 3
```

```
/.../01:Folder 2  
? 02:File 3
```

```
Copies  
001
```

```
Copies
                                010
```

```
Paper Source
? Cassette 1
```

```
Paper Source
? Cassette 2
```

```
>Remove Device ?
```

```
>Print File List ?
```

Copies (Number of copies)

Sets the number of copies printed of the specified file in USB flash memory.

IMPORTANT To use this feature, the RAM disk must be set to On.

1 While `Copies` in step 5 above is displayed, press Δ and ∇ or \triangleleft and \triangleright to display the number of copies. (E.g.: 10)

2 Press **[OK]**. `Paper Source` and a question mark (?) appears.

Paper Source (Selecting the paper feed source)

Sets the paper used for printing the specified file in USB flash memory.

1 While `Paper Source` in step 2 above is displayed, press Δ and ∇ or \triangleleft and \triangleright repeatedly until the paper source appears. (For example : `Cassette 2`)

Note that menus shown in the list may vary depending on which optional units installed in the printer.

2 Press **[OK]**. The message `Processing` appears and the printer prints a file stored in a USB flash memory.

Remove Device (Removing the USB flash memory)

Specifies the setting for USB flash memory removal.

1 Press \triangleright while `USB Memory >` is displayed.

2 Press Δ or ∇ repeatedly until `>Remove Device` appears.

3 Press **[OK]**. A question mark (?) appears.

4 Press **[OK]** again. Menu display ends and the USB flash memory device can be removed.

Print File List (Printing a list of the files on a USB flash memory)

This allows you to print a list of the files on a USB flash memory device.

1 Press \triangleright while `USB Memory >` is displayed.

2 Press Δ or ∇ repeatedly until `>Print File List` appears.

3 Press **[OK]**. A question mark (?) appears.

4 Press **[OK]** again. The message `Processing` appears and the printer prints a list of files stored in a USB flash memory.

Counter (Viewing the counter value)

This only displays the total number of pages printed. You cannot change the displayed number.



Counter >

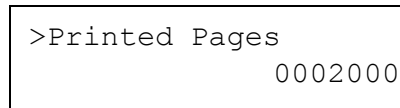

>Printed Pages
0002000

- 1** Press **[MENU]**.
- 2** Press Δ or ∇ repeatedly until Counter > appears.
- 3** Press \triangleright . >Printed Pages appears as the total number of pages printed. (E.g.: 2000)
- 4** Press **[MENU]**. The display returns to Ready.

Paper Settings

This sets the paper size and type for the MP tray and cassettes from which paper is supplied.

The options available in Paper Settings are as follows:

- MP Tray Size (Setting MP tray paper size)
- MP Tray Type (Setting the MP tray paper type)
- Cassette (1 to 3) Size (Setting the cassette paper size)
- Cassette (1 to 3) Type (Setting the cassette paper type)
- Type Adjust (Creating custom paper type)
- Reset Type Adjust (Resetting the custom paper type)

1 Press **[MENU]**.

2 Press Δ or ∇ repeatedly until `Paper Settings >` appears.

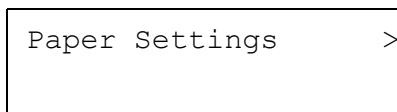

MP Tray Size (Setting MP tray paper size)

When you use the MP tray, you should set the MP tray size to the paper size that is used to format the job to print. If the sizes do not match, printing will not be performed on the correct size paper.

The default setting is `Letter` size for the U.S. and Canada and `A4` for other countries. For more information about the paper sizes that you can feed from the MP tray, refer to **Paper Specifications** on page 1-2.



Note Feeding the paper having a paper size which does not match the current paper size from the MP tray can cause paper jam.

- 1 Press `>` while `Paper Settings >` is displayed.
- 2 Press `△` or `▽` repeatedly until `>MP Tray Size` appears.
- 3 Press **[OK]**. A blinking question mark (?) appears.

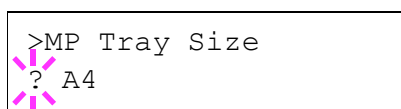

- 4 Press `△` or `▽` to display the desired paper size. The message display toggles through the following paper sizes:

Env. Monarch
Envelope #10
Envelope #9
Envelope #6
Envelope DL
Envelope C5
A6
B6
A5
B5
ISO B5
A4
Executive
Letter
Legal
Custom
Oficio II
Statement
Folio
Youkei 2
Youkei 4
16K
Hagaki
OufukuHagaki

- 5 Press **[OK]**.
- 6 Press **[MENU]**. The display returns to `Ready`.

MP Tray Type (Setting the MP tray paper type)

You can use this to set the paper type that can be supplied from the MP tray. The default setting is `PLAIN`.

For more information about paper types that you can feed from the MP tray, refer to **Paper Specifications** on page 1-2.

- 1 Press `>` while `Paper Settings >` is displayed.
- 2 Press `△` or `▽` repeatedly until `>MP Tray Type` appears.

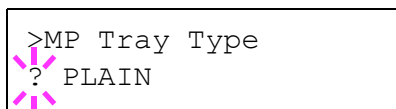

3 Press **[OK]**. A blinking question mark (?) appears.

4 Press Δ or ∇ to display the desired paper type. The message display toggles through the following paper types:

PLAIN
TRANSPARENCY
PREPRINTED
LABELS
BOND
RECYCLED
VELLUM
ROUGH
LETTERHEAD
COLOR
PREPUNCHED
ENVELOPE
CARDSTOCK
THICK
HIGH QUALITY
CUSTOM 1 (to 8)



Note You can define any paper type and store that definition in the printer. For more information, refer to **Type Adjust (Creating custom paper type)** on page 2-25.

5 Press **[OK]**.

6 Press **[MENU]**. The display returns to Ready.

Cassette (1 to 3) Size (Setting the cassette paper size)

To set the size for the paper cassette, load the paper into a paper cassette, adjust the paper size, and select the paper size from the operation panel.

If the PF-100 optional paper feeder is installed, use the same procedure to load paper into the paper feeder cassettes.

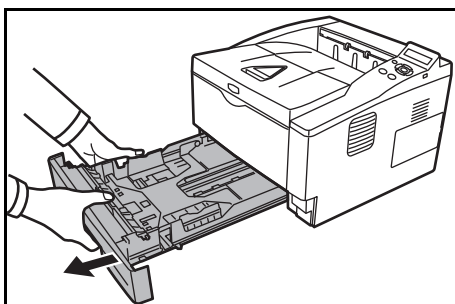

1 Pull the cassette out of the printer.

2 Adjust the position of the width guides located on the left and right sides of the cassette. Press the release button on the left guide and slide the guides to the paper size required, and load the paper into the cassette.

Proceed to the next section to select the paper size from the operation panel.

Setting the Paper Size from the Operation Panel

Use the operation panel to set the size of paper loaded in the cassette on the printer.

- 1 Press \triangleright while `Paper Settings >` is displayed.
- 2 Press \triangle or ∇ repeatedly until `>Cassette Size >` appears. If optional paper feeders are added, `Cassette1 Size` will appear for the standard paper cassette and `Cassette2 Size`, and `Cassette3 Size` will appear for the optional paper feeders.
- 3 Press **[OK]**. A blinking question mark (?) appears.

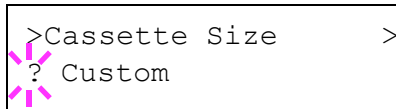

- 4 Press \triangle or ∇ to display the desired paper size. The message display toggles through the following paper sizes:

Envelope C5
A6
A5
B5
ISO B5
A4
Executive
Letter
Legal
Custom
Oficio II
Statement
Folio
16K



Note A6 and Statement will not appear if `Cassette 2` to `3` of optional paper feeder PF-100 is selected.

- 5 When the desired paper size is displayed, press **[OK]**. The paper size is set for the paper cassette.
If you selected `Custom` in step 4, be sure to set the unit of measurement and the dimensions of the paper as described in the following sections.

Select the units of measurement as described in the next section.

Unit (Selecting the unit of measurement)

- 1 Press \triangleright .
- 2 Press \triangle or ∇ repeatedly until \gg Unit appears. The unit of measurement can be selected between millimeters and inches. The current unit of measurement is displayed (the default setting is mm).
- 3 Press **[OK]**. A blinking question mark (?) appears.
- 4 Select mm or inch using \triangle or ∇ .
- 5 Press **[OK]**.
Set the dimensions of the paper as described in the next section.



Entering the Width and Length

Enter the paper size for X Dimension and Y Dimension as shown in the figure.

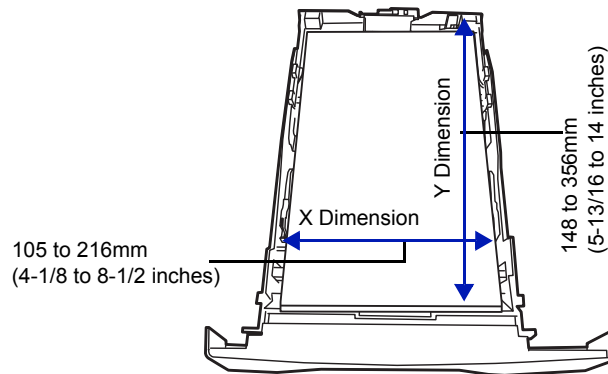

- 1 When the unit of measurement is set, press ∇ .
 \gg X Dimension appears (the paper width setting).
- 2 Press **[OK]**. A blinking cursor ($_$) appears.
- 3 Press \triangle or ∇ to increase or decrease the value of the figure where the cursor is blinking and display the desired width.
Acceptable paper widths are as follows:
 - Cassette: 105 to 216 mm (4.13 to 8.5 inches)
 - Paper Feeder PF-100 (optional): 148 to 216 mm (5.83 to 8.5 inches)
- 4 Display the paper width and press **[OK]**.
- 5 When the width is set, press ∇ . \gg Y Dimension appears (the paper length setting). Set the desired length in the same way as the width.
Acceptable paper lengths are as follows:
 - Cassette: 148 to 356 mm (5.83 to 14.02 inches)
 - Paper Feeder PF-100 (optional): 210 to 356 mm (8.5 to 14.02 inches)
- 6 Display the paper length, press **[OK]**.
- 7 Press **[MENU]**. The display returns to Ready.

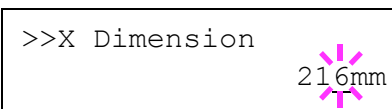

Cassette (1 to 3) Type (Setting the cassette paper type)

By setting a paper type (plain, recycled, etc.) for the paper cassette, you can automatically select the paper in the paper cassette according to the paper type you command on the printer driver. The default setting is plain paper for all paper cassettes.

If the PF-100 optional paper feeder is installed, use the same procedure to setting the cassette paper type.

For more information about paper types that you can feed from the paper cassette, refer to **Paper Specifications** on page 1-2.

1 Press \triangleright while Paper Settings > is displayed.

2 Press \triangle or ∇ repeatedly until >Cassette Type appears.

If optional paper feeders are added, Cassette 1 Type will appear for the standard paper cassette and Cassette 2 Type, and Cassette 3 Type will appear for the optional paper feeders.

3 To change paper type, press **[OK]**. A blinking question mark (?) appears.

4 Press \triangle or ∇ to display the desired paper type. The message display toggles through the following paper types:

PLAIN
PREPRINTED
BOND
RECYCLED
ROUGH
LETTERHEAD
COLOR
PREPUNCHED
HIGH QUALITY
CUSTOM 1 (to 8)



Note You can define any paper type and store that definition in the printer. For more information, refer to **Type Adjust (Creating custom paper type)** on page 2-25.

5 Press **[OK]**.

6 Press **[MENU]**. The display returns to Ready.

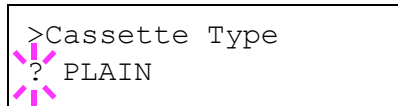

Type Adjust (Creating custom paper type)

The following describes the procedure used to set a user-defined paper type for the printer. Eight custom user settings may be registered. After having been set, any of these may be called up when setting the paper type for a paper source.

The paper weight and duplex path can be set (refer to **Paper Weight (Setting the paper weight)** on page 2-25, and **Duplex Path (Setting the duplex path)** on page 2-26) after selecting the paper type to be customized as follows. For how to reset the customized settings, refer to **Reset Type Adjust (Resetting the custom paper type)** on page 2-26.

- 1 Press \triangleright while `Paper Settings >` is displayed.
- 2 Press \triangle or ∇ repeatedly until `>Type Adjust >` appears.
- 3 Press **[OK]**. A blinking question mark (?) appears.

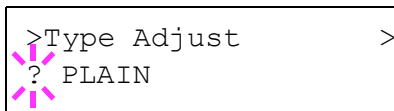

```
>Type Adjust >
? PLAIN
```

- 4 Press \triangle or ∇ to display the desired paper type. The display changes as shown below.

```
PLAIN
TRANSPARENCY
PREPRINTED
LABELS
BOND
RECYCLED
VELLUM
ROUGH
LETTERHEAD
COLOR
PREPUNCHED
ENVELOPE
CARDSTOCK
THICK
HIGH QUALITY
CUSTOM 1 (to 8)
```

- 5 Press **[OK]**.
- 6 Press \triangleright and proceed to the next step **Paper Weight (Setting the paper weight)**.

Paper Weight (Setting the paper weight)

You can set the paper thickness for your custom paper type to be customized.

- 1 Display the custom paper type (refer to **Type Adjust (Creating custom paper type)** on page 2-25) and press \triangleright .
- 2 Press \triangle or ∇ repeatedly until `>>Paper Weight` appears.
- 3 Press **[OK]**. A blinking question mark (?) appears.

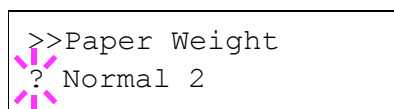

```
>>Paper Weight
? Normal 2
```

- 4 Press Δ or ∇ to display the desired paper thickness. The display changes as shown below. For details of the default setting for each paper type, refer to **Paper Specifications** on page 1-2.

Light
Normal 1
Normal 2
Normal 3
Heavy 1
Heavy 2
Heavy 3
Extra Heavy

- 5 Press [OK].
- 6 Press [MENU]. The display returns to Ready.

Duplex Path (Setting the duplex path)

- 1 Display the custom paper type (refer to **Type Adjust (Creating custom paper type)** on page 2-25) and press \triangleright .
- 2 Press Δ or ∇ repeatedly until >>Duplex Path appears.
- 3 Press [OK]. A blinking question mark (?) appears.

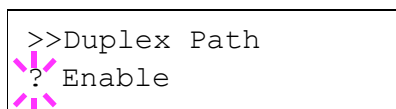

```
>>Duplex Path
? Enable
```

- 4 Select Enable or Disable using Δ or ∇ . For details of the default setting for each paper type, refer to **Paper Specifications** on page 1-2.
 - 5 Press [OK].
 - 6 Press [MENU]. The display returns to Ready.
- The custom paper type setting is completed.

Print Density (Selecting the print density)

The print density can be adjusted in five steps: from 01 (light) to 05 (dark). The factory setting is 03.

- 1 Display the custom paper type (refer to **Type Adjust (Creating custom paper type)** on page 2-25) and press \triangleright .
- 2 Press Δ or ∇ repeatedly until >>Print Density appears.
- 3 Press [OK]. A blinking question mark (?) appears.

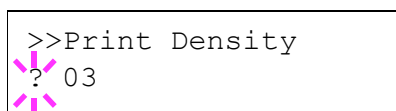

```
>>Print Density
? 03
```

- 4 Select the print density from five steps from 01 (light) to 05 (dark) using the Δ or ∇ .
- 5 Press [OK].
- 6 Press [MENU]. The display returns to Ready.

Reset Type Adjust (Resetting the custom paper type)

Reset all the custom paper type that was set in **Type Adjust (Creating custom paper type)** on page 2-25.

- 1 Press \triangleright while Paper Settings > is displayed.
- 2 Press Δ or ∇ repeatedly until >Reset Type Adjust appears.
- 3 Press [OK]. A question mark (?) appears.

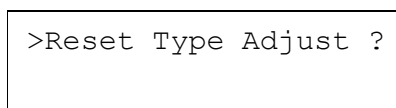

```
>Reset Type Adjust ?
```

-
- 4 Press **[OK]** again. All customized paper types will be reset to the default. The display returns to *Ready*.

Print Settings

These settings specify printing parameters such as the print quality used for printing (Normal or Fine), the gloss mode (Low or High), the number of copies, reduced printing and the page orientation.

The options available in Print Quality are as follows:

- Paper Source (Selecting the paper feed source)
- Paper Feed Mode (Setting the paper feed source)
- Duplex (Duplex Printing)
- Override A4/LT (Overriding difference between A4 and Letter)
- Emulation (Setting the emulation)
- Font Select (Selecting the default font)
- Code Set (Setting the code set)
- Print Quality (Setting print quality)
- Page Set (Setting pagination)

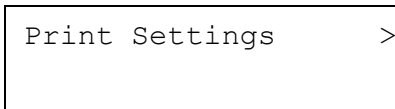

```
Print Settings >
```

- 1 Press **[MENU]**.
- 2 Press Δ or ∇ repeatedly until `Print Settings >` appears.

Paper Source (Selecting the paper feed source)

You can select the paper source, from which the printer feeds paper as the default. If an optional paper feeder(s) is installed, it is also available for the default paper source.

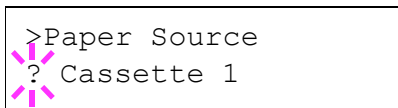

```
>Paper Source  
? Cassette 1
```

- 1 Press \triangleright while `Print Settings >` is displayed.
- 2 Press Δ or ∇ repeatedly until `>Paper Source` appears.
- 3 To change the current paper feed source, press **[OK]**. A blinking question mark (?) appears.
- 4 Press Δ or ∇ to display the desired paper feed source. The message display toggles through the following paper feed sources, depending on the installed optional paper feeders (from the top most paper cassette to the bottom paper cassette):

```
MP tray  
Cassette 1  
Cassette 2  
Cassette 3
```

Cassettes 2 and 3 are available for selection when the optional paper feeders are installed.

- 5 Press **[OK]**.
- 6 Press **[MENU]**. The display returns to `Ready`.

Paper Feed Mode (Setting the paper feed source)

This mode specifies how the paper should be fed, after the paper feed source and paper type has been chosen. If `Auto` is selected, the printer searches for a paper feed source that matches the paper size and type, and paper is delivered from that source. An error message is displayed if `Fixed` is selected, but a match is not found. The default setting is `Auto`. To change the settings, follow the steps described below.



- 1 Press `▷` while `Print Settings >` is displayed.
- 2 Press `△` or `▽` repeatedly until `>Paper Feed Mode` appears.
- 3 Press `[OK]`. A blinking question mark (?) appears.
- 4 Press `△` or `▽` until `Auto` or `Fixed` appears.
- 5 Press `[OK]`.
- 6 Press `[MENU]`. The display returns to `Ready`.

When the Paper Runs Out During Printing

When `Paper Feed Mode` is set to `Fixed`, if the paper in the cassette runs out during printing, `Load Cassette 1` is displayed and the printer stands by. In this event, either replenish the paper in the empty cassette or use the procedure below to print from another paper source.

- 1 While `Load Cassette 1` is displayed, press `△` or `▽` repeatedly until `Use alternative?` appears.
- 2 Press `△` or `▽` repeatedly until the desired paper source and size appears.
Each time you press `△` or `▽`, another paper cassette or the paper size that can currently be fed from the MP tray appears.
- 3 Press `[OK]`. Printing continues.

Duplex (Duplex printing)

Using the duplexer, you can automatically print on both sides of the paper. The duplexer is mounted underneath the printer.

Duplex printing is available for the following paper types:

PLAIN
PREPRINTED
BOND
RECYCLED
ROUGH
COLOR
PREPUNCHED
HIGH QUALITY
CUSTOM 1 (to 8)

Activating the duplexer is done by selecting either short edge or long edge binding mode.



Note Duplex printing can be also performed from the MP tray. If the paper to be fed from the MP tray does not match the paper size and paper type of the current paper feed source cassette, a paper jam may occur.

Binding Modes

Binding refers to the manner in which printed pages of paper are joined together (by gluing, stitching, etc.) in book form. The two possible types of binding are: long-edge binding, in which pages are joined together along their long edge; and short-edge binding, in which they are joined together along their short edge. In selecting a binding type, you must also consider the orientation of the printed page. You can use long-edge or short-edge binding with either landscape or portrait printing.

Depending on the binding type and print orientation, the duplexer provides four types of binding. These are: (1) portrait, long-edge, (2) portrait, short edge, (3) landscape, long-edge, and (4) landscape, short-edge. The figure below shows these binding methods.

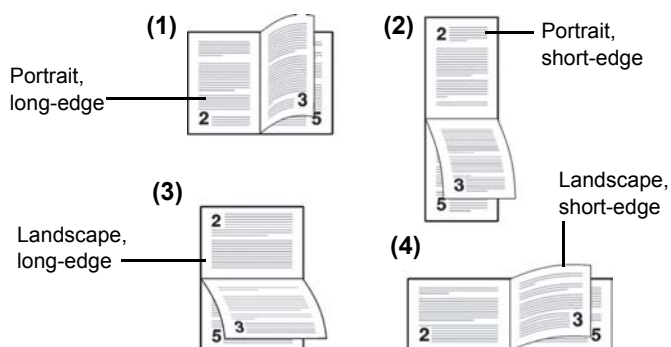

- 1 Press \triangleright while `Print Settings >` is displayed.
- 2 Press \triangle or ∇ repeatedly until `>Duplex` appears.
- 3 Press **[OK]**. A blinking question mark (?) appears.

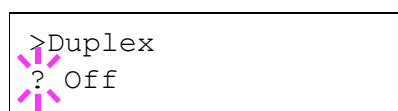

- 4 Press Δ or ∇ to display the desired binding mode. The message display toggles through the following:

Off (default)
Short edge bind
Long edge bind

- 5 Press **[OK]**.
- 6 Press **[MENU]**. The display returns to Ready.

Override A4/LT (Overriding difference between A4 and Letter)

When the `Override A4/LT` is turned On using the operation panel, the printer ignores the difference between A4 and Letter paper sizes. Printing is performed without an error message even if the actual paper size in the current cassette differs from the paper size formatting the job.

By default, this feature is On.

- 1 Press \triangleright while `Print Settings >` is displayed.
- 2 Press Δ or ∇ repeatedly until `>Override A4/LT` appears.
- 3 Press **[OK]**. A blinking question mark (?) appears.

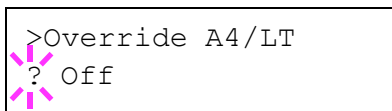

```
>Override A4/LT
? Off
```

- 4 Select On or Off using Δ or ∇ .
- 5 Press **[OK]**.
- 6 Press **[MENU]**. The display returns to Ready.

Emulation (Setting the emulation)

You can change the emulation mode. Use the procedure below to select the mode.

- 1 Press \triangleright while `Print Settings >` is displayed.
- 2 Press Δ or ∇ repeatedly until `>Emulation >` appears on the message display. One of the emulation modes appears, indicating the emulation currently in use.
- 3 Press **[OK]**. A blinking question mark (?) appears.

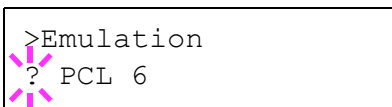

```
>Emulation
? PCL 6
```

- 4 Press Δ or ∇ repeatedly until the desired emulation mode is displayed.

PCL 6 (default)
KPDL
KPDL (AUTO)
Line Printer
IBM Proprinter
DIABLO 630
EPSON LQ-850

- 5 Press **[OK]**.
- 6 Press **[MENU]**. The display returns to Ready.

Alternative Emulation for KPDL Emulation

KPDL is Kyocera's implementation of the PostScript language. The KPDL (AUTO) emulation enables the printer to automatically change the emulation mode according to the data received when printing.

In addition to KPDL (AUTO) emulation, you can use the operation panel to set another emulation mode that is used very often. The default setting is PCL 6.

```
>Emulation
? PCL 6
```

```
>Emulation
? KPDL (AUTO)
```

```
>>Alt. Emulation
PCL 6
```

- 1 Press **[MENU]**.
- 2 Press Δ or ∇ repeatedly until `>Emulation >` appears on the message display.
- 3 Press **[OK]**. A blinking question mark (?) appears.
- 4 Press Δ or ∇ repeatedly until `KPDL (AUTO)` appears.
- 5 Press **[OK]**.
- 6 Press \triangleright . When `>>Alt. Emulation` is displayed, press Δ or ∇ . The names of alternative emulations appear - PCL 6, Line Printer, IBM Proprinter, DIABLO 630 or EPSON LQ-850.
- 7 Press **[OK]**. A blinking question mark (?) appears.
- 8 Press Δ or ∇ repeatedly until the desired alternative emulation appears.
- 9 Press **[OK]**.
- 10 Press **[MENU]**. The display returns to `Ready`.

Error Report (Printing KPD L errors)

The printer can print error descriptions when printing error occurs during KPDL emulation. The default changes according to the destination.

```
>Emulation
? PCL 6
```

```
>Emulation >
? KPDL (AUTO)
```

```
>>Error Report
? On
```

- 1 Press \triangleright while `Print Settings >` is displayed.
- 2 Press Δ or ∇ repeatedly until `>Emulation >` appears.
- 3 Press **[OK]**. A blinking question mark (?) appears.
- 4 Select `KPDL` or `KPDL (AUTO)` using Δ or ∇ . Press **[OK]**.
- 5 Press \triangleright . `>>Error Report` appears.
- 6 Press **[OK]**. A blinking question mark (?) appears.
- 7 Select `On` or `Off` using Δ or ∇ . Press **[OK]**.
- 8 Press **[MENU]**. The display returns to `Ready`.

Font Select (Selecting the default font)

You can select the default font. The default font can be one of the internal fonts or a font that is downloaded to the printer memory or stored on CompactFlash (CF) card.

In this menu, you can also set the type and pitch for Courier and Letter Gothic; as well as to print a font list.

```
>Font Select >
  Internal
```

```
>> I000
```

```
>>?I000
```

- 1 Press \triangleright while `Print Settings >` is displayed.
- 2 Press \triangle or ∇ repeatedly until `>Font Select >` appears.
- 3 To select an internal font, make sure that `Internal` is displayed and press \triangleright . The display changes. If `Internal` is not displayed, press **[OK]**, then press \triangle or ∇ until it appears.

To select an optional font, press **[OK]** while `>Font Select >` is displayed. Press \triangle or ∇ repeatedly until `Option` appears and then press **[OK]**. Press \triangleright next to display the font selection shown above. You can perform this operation only when optional fonts are installed in the printer.

The letter before the number indicates the location of the font, as shown below.

I: Internal font
S: Soft (downloaded) font
M: Fonts in optional CompactFlash card
H: Fonts in RAM disk

- 4 Press **[OK]**. A blinking question mark (?) appears.
- 5 Press \triangle or ∇ repeatedly until the desired font number appears. For font numbers of the internal fonts, refer to **Print Fonts List** on page 2-15.
- 6 When the desired font is displayed, press **[OK]**.
- 7 Press **[MENU]**. The display returns to `Ready`.

Selecting Regular or Dark Courier/Letter Gothic

Courier or Letter Gothic font thickness can be selected as `Regular` or `Dark`. In the procedure below, it is assumed that `Courier` is selected. The procedure is the same for `Letter Gothic`.

```
>Font Select >
  Internal
```

```
>>Courier
  Regular
```

- 1 Press \triangleright while `Print Settings >` is displayed.
- 2 Press \triangle or ∇ repeatedly until `>Font Select >` appears.
- 3 Make sure that `Internal` is displayed and press \triangleright .
- 4 Press \triangle or ∇ repeatedly until `>>Courier` appears. If you are selecting the thickness of the `Letter Gothic` font, choose `>> Letter Gothic here` instead.

```
>>Courier
? Regular
```

5 Press **[OK]**. A blinking question mark (?) appears.

6 Select `Regular` or `Dark` using Δ or ∇ .

7 Press **[OK]**.

8 Press **[MENU]**. The display returns to `Ready`.

Changing the Default Font Size

You can change the size of the default font. If you selected a proportional font, the character size can also be changed.

1 Press \triangleright while `Print Settings >` is displayed.

2 Press Δ or ∇ repeatedly until `>Font Select >` appears.

```
>Font Select >
Internal
```

3 Make sure that `Internal` is displayed and press \triangleright .

4 Press Δ or ∇ repeatedly until `>>Size` appears.

```
>>Size
012.00 point(s)
```

5 Press **[OK]**. A blinking question mark (?) appears.

```
>>Size
012.00 point(s)
```

6 Press Δ or ∇ to increase or decrease the value at the blinking cursor. The font size can be set between 4 and 999.75 points, in 0.25-point increments. Use \triangleright or \triangleleft to move the cursor right and left.

7 When the desired size is displayed, press **[OK]**.

8 Press **[MENU]**. The display returns to `Ready`.

Character Pitch

You can set the character pitch for fixed fonts.

1 Press \triangleright while `Print Settings >` is displayed.

2 Press Δ or ∇ repeatedly until `>Font Select >` appears.

```
>Font Select >
Internal
```

3 Make sure that `Internal` is displayed and press \triangleright .

4 Press Δ or ∇ repeatedly until `>>Pitch` appears.

```
>>Pitch
10.00 cpi
```

5 Press **[OK]**. A blinking question mark (?) appears.

```
>>Pitch
10.00 cpi
```

6 Press Δ or ∇ to increase or decrease the value at the blinking cursor. The character pitch can be set 0.44 and 99.99 characters per inch, in 0.01 character-per-inch increments. Use \triangleright or \triangleleft to move the cursor right and left.

7 When the desired size is displayed, press **[OK]**.

8 Press **[MENU]**. The display returns to *Ready*.

Code Set (Setting the code set)

You can change the character code set. Available character code sets vary depending on the current font. (The default is *IBM PC-8*.)

1 Press **▷** while *Print Settings >* is displayed.

2 Press **△** or **▽** repeatedly until *>Code Set* appears.

3 Press **[OK]**. A blinking question mark (?) appears.

4 Press **△** or **▽** until the desired character code set appears.

5 Press **[OK]**.

6 Press **[MENU]**. The display returns to *Ready*.

```
>Code Set
  IBM PC-8
```

```
>Code Set
? IBM PC-8
```

Print Quality (Setting print quality)

In *Print Quality* menus, you can set the following settings.

The options available in *Print Quality* are as follows:

- KIR Mode (Selecting the KIR mode)
- EcoPrint Mode (Selecting the EcoPrint mode)
- Resolution (Selecting the Print Resolution)

1 Press **▷** while *Print Settings >* is displayed.

2 Press **△** or **▽** repeatedly until *>Print Quality >* appears.

```
>Print Quality >
```

KIR Mode (Selecting the KIR mode)

This printer incorporates the KIR (Kyocera Image Refinement) smoothing function. KIR uses the software to enhance resolution, resulting in high quality printing at resolution of 600 dpi and 300 dpi. The default is *On*. KIR has no effect on the printing speed.

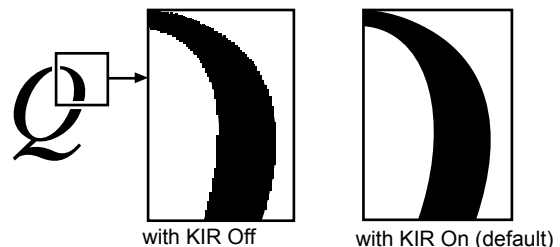

1 Press **▷** while *>Print Quality >* is displayed.

2 Press **△** or **▽** repeatedly until *>>KIR Mode* appears.



3 Press **[OK]**. A blinking question mark (?) appears.

4 Select *On* or *Off* using Δ or ∇ .

5 Press **[OK]**.

6 Press **[MENU]**. The display returns to *Ready*.

EcoPrint Mode (Selecting the EcoPrint mode)

By enabling EcoPrint mode, you can minimize the amount of toner used during printing. Because images printed in this mode may be slightly coarser than those printed in standard resolution, you should use EcoPrint for test prints or other situations where high-quality prints are not required.

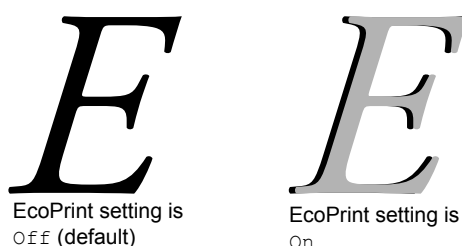

Use the procedure below to select EcoPrint mode. The default setting is *Off*.

1 Press \triangleright while *>Print Quality >* is displayed.

2 Press Δ or ∇ repeatedly until *>>EcoPrint Mode* appears.

3 Press **[OK]**. A blinking question mark (?) appears.

4 Select *On* or *Off* using Δ or ∇ .

5 Press **[OK]**.

6 Press **[MENU]**. The display returns to *Ready*.

Resolution (Selecting the print resolution)

You can set the default print resolution in four ways: 300dpi, 600dpi, Fast 1200 mode and Fine 1200 mode. The clarity of printed characters and graphics becomes sharper in this order.

1 Press \triangleright while *>Print Quality >* is displayed.

2 Press Δ or ∇ repeatedly until *>>Resolution* appears.

3 Press **[OK]**. A blinking question mark (?) appears.

4 Select *Fine 1200 mode*, *Fast 1200 mode*, *600 dpi* or *300 dpi* using the Δ or ∇ .

5 Press **[OK]**.

6 Press **[MENU]**. The display returns to *Ready*.

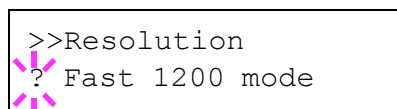
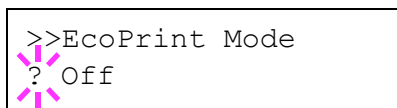

Page Set (Setting pagination)

In Page Set menus, you can set the number of copies, page orientation, and other settings regarding pagination.

The options available in Page Set are as follows:

- Copies (Number of copies)
- Orientation (Print orientation)
- LF Action (Linefeed)
- CR Action (Carriage-Return)
- Wide A4 (Wide A4 pitch)
- XPS FitTo Page (Print area setting for XPS data)
- TIFF Size (Print mode setting for TIFF files)

- 1 Press \triangleright while `Print Settings >` is displayed.
- 2 Press \triangle or ∇ repeatedly until `>Page Set >` appears.

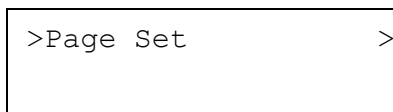

Copies (Number of copies)

You can set the number of copies of each page to be printed.

- 1 Press \triangleright while `>Page Set >` is displayed.
- 2 Press \triangle or ∇ repeatedly until `>>Copies` appears.
- 3 Press **[OK]**. A blinking cursor () appears.



- 4 Press \triangle or ∇ to increase or decrease, respectively, the value at the blinking cursor. The number of copies can be set between 1 and 999. Use \triangleleft and \triangleright to move the cursor right and left.
- 5 When the desired size is displayed, press **[OK]**.
- 6 Press **[MENU]**. The display returns to `Ready`.

Orientation (Print orientation)

You can select portrait (upright) or landscape (sideways) page orientation.

Portrait Orientation

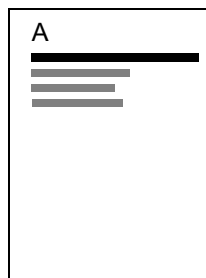

Landscape Orientation



- 1 Press \triangleright while `>Page Set >` is displayed.
- 2 Press \triangle or ∇ repeatedly until `>>Orientation` appears.

```
>>Orientation
? Portrait
```

3 Press **[OK]**. A blinking question mark (?) appears.

4 Select `Portrait` or `Landscape` using Δ or ∇ .

5 Press **[OK]**.

6 Press **[MENU]**. The display returns to `Ready`.

LF Action (Linefeed)

This procedure instructs the printer what to do when it receives a linefeed code (0AH).

- `LF only`: Linefeed is performed (Default).
- `CR and LF`: A linefeed and carriage return are performed.
- `Ignore LF`: The linefeed is ignored.

1 Press \triangleright while `>Page Set >` is displayed.

2 Press Δ or ∇ repeatedly until `>>LF Action` appears.

3 Press **[OK]**. A blinking cursor (`_`) appears.

```
>>LF Action
? LF only
```

4 Press Δ or ∇ repeatedly until the desired linefeed action appears.

5 When the desired action is displayed, press **[OK]**.

6 Press **[MENU]**. The display returns to `Ready`.

CR Action (Carriage-Return)

This procedure instructs the printer what to do when it receives a carriage return code (0DH).

- `CR only`: A carriage-return is performed (Default).
- `CR and LF`: A linefeed and carriage return are performed.
- `Ignore CR`: The carriage-return is ignored.

1 Press \triangleright while `>Page Set >` is displayed.

2 Press Δ or ∇ repeatedly until `>>CR Action` appears.

3 Press **[OK]**. A blinking cursor (`_`) appears.

```
>>CR Action
? CR only
```

4 Press Δ or ∇ repeatedly until the desired carriage-return appears.

5 When the desired action is displayed, press **[OK]**.

6 Press **[MENU]**. The display returns to `Ready`.

Wide A4 (Wide A4 pitch)

Turn this to `On` to increase the maximum number of characters that can be printed in a line for an A4 page (78 characters at 10 pitch) and Letter size page (80 characters at 10 pitch). This setting is only effective in PCL 6 emulation.

1 Press \triangleright while `>Page Set >` is displayed.

2 Press Δ or ∇ repeatedly until `>>Wide A4` appears.

```
>>Wide A4
? Off
```

3 Press **[OK]**. A blinking question mark (?) appears.

4 Select **On** or **Off** using Δ or ∇ .

5 Press **[OK]**.

6 Press **[MENU]**. The display returns to **Ready**.

XPS FitTo Page (Print area setting for XPS data)

If you select **On** in this setting, XPS data is scaled to fit the paper size during printing. If you select **Off**, the data is printed at its original size.

1 Press \triangleright while **>Page Set >** is displayed.

2 Press Δ or ∇ repeatedly until **>>XPS FitTo Page** appears.

3 Press **[OK]**. A blinking question mark (?) appears.

```
>>XPS FitTo Page
? Off
```

4 Select **On** or **Off** using Δ or ∇ .

5 Press **[OK]**.

6 Press **[MENU]**. The display returns to **Ready**.

TIFF Size (Print mode setting for TIFF files)

Sets the print mode for TIFF files. The default setting is **Paper Size**.

1 Press \triangleright while **>Page Set >** is displayed.

2 Press Δ or ∇ repeatedly until **>>TIFF Size** appears.

3 Press **[OK]**. A blinking question mark (?) appears.

```
>>TIFF Size
? Paper Size
```

4 Press Δ or ∇ repeatedly until the desired print mode is displayed. The list shows the following print modes:

Paper Size (scaled to fit the paper size)

Image Resolution (matched to the image resolution)

Print Resolution (matched to the print resolution)

5 Press **[OK]**.

6 Press **[MENU]**. The display returns to **Ready**.

Network (Network settings)

This printer supports TCP/IP and TCP/IP (IPv6) protocols.

IP is an abbreviation for Internet Protocol. This printer routinely uses the TCP/IP (IPv4) protocol, but provides a separate setting for the next-generation IP, IPv6.

TCP/IP (IPv4) uses 32-bit IP addresses, but the rapid growth in the number of Internet users has resulted in a shortage of IP addresses. IPv6 was developed to expand the range of available IP addresses by using 128-bit IP addresses.

The options available in the Network settings are as follows:

- TCP/IP (IPv4 settings)
- TCP/IP (IPv6) (IPv6 settings)



Note Check with your network administrator when selecting the network setting.

After all network related settings have been done, turn the machine OFF and ON again. This is mandatory to make the settings effective.

- 1 Press [MENU].
- 2 Press Δ or ∇ repeatedly until `Network >` appears.

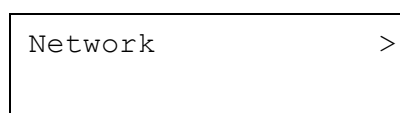

TCP/IP (IPv4 settings)

This selects the settings for TCP/IP (IPv4).

The TCP/IP system refers to the Internet system, which has a 5-layer structure consisting of the interface layer, link layer, network (IP) layer, transport (TCP/UDP) layer and application layer.

The interface layer is a key layer in the TCP/IP system that provides an abstracted interface that is not dependent on the link (communication line: frame relay or Ethernet, etc.) to the IP module (IP layer). This means that the IP module can use this abstracted interface (which is not dependent on the link type) to exchange IP packets back and forth with the link layer.

The options available in the TCP/IP (IPv4) settings are as follows:

- DHCP (DHCP setting)
- IP Address (IP address setting)
- Subnet Mask (Subnet mask setting)
- Gateway (Gateway setting)
- Bonjour (Bonjour setting)

IMPORTANT The DHCP, IP address, subnet mask, gateway and Bonjour menu options for TCP/IP are displayed when TCP/IP is enabled.

- 1 Press \triangleright while `Network >` is displayed.
- 2 Press Δ or ∇ repeatedly until `>TCP/IP >` appears.
- 3 Press [OK]. A blinking question mark (?) appears.

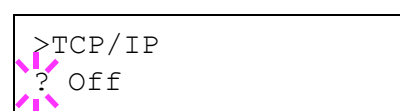

- 4 Select **On** or **Off** using Δ or ∇ .
- 5 Select **On** and press **[OK]**. The display changes to the settings shown below.

DHCP (DHCP setting)

DHCP (Dynamic Host Configuration Protocol) is the protocol that assigns the information required to establish a network connection when a host attempts to connect to the network (Internet). This information includes the IP address of the local node and the default router (the router in the host's own network system) and the DNS (Domain Name System) server. DHCP is an extension of the BOOTP (Bootstrap) startup protocol.

- 1 Press \triangleright while **>TCP/IP On >** is displayed.
- 2 Press Δ or ∇ repeatedly until **>>DHCP** appears.
- 3 Press **[OK]**. A blinking question mark (?) appears.



- 4 Select **On** or **Off** using Δ or ∇ .
- 5 Press **[OK]**.
- 6 Press **[MENU]**. The display returns to **Ready**.

IP Address (IP address setting)

An IP address is the address of a network device such as a computer and is included in IP packets as needed for the sending and receiving of Internet data (IP packets). (IP addresses can be either destination addresses or source addresses.)

Specifically, an IP address is a bit string consisting of a host address (or host section) that identifies a computer (host) connected to the Internet and a network address (or network section) that identifies the network to which that computer belongs (or more specifically, the computer's network interface). Bit strings (IP addresses) that are unique throughout the entire Internet system are allocated to each computer or interface.

The IP addresses currently used on the Internet (IPv4) have a fixed length of 32 bits.



Note When you enter the IP address, be sure to set the DHCP setting to **Off**.

- 1 Press \triangleright while **>TCP/IP On >** is displayed.
- 2 Press Δ or ∇ repeatedly until **>>IP Address** appears.
- 3 Press **[OK]**. A blinking cursor (`_`) appears.

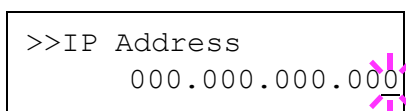

- 4 Press Δ or ∇ to increase or decrease, respectively, the value at the blinking cursor. You can set any value between **000** and **255**. Use \triangleleft and \triangleright to move the cursor right and left.
- 5 Display the desired IP address and press **[OK]**.
- 6 Press **[MENU]**. The display returns to **Ready**.

Subnet Mask (Subnet mask setting)

The subnet mask is a way of augmenting the network address section of an IP address.

A subnet mask represents all network address sections as 1 and all host address sections as 0. The number of bits in the prefix indicates the length of the network address. The term "prefix" refers to something added to the beginning and, in this context, indicates the first section of the IP address.

When an IP address is written, the length of the network address can be indicated by the prefix length after a forward slash (/). For example, "24" in the address "133.210.2.0/24". In this way, "133.210.2.0/24" denotes the IP address "133.210.2.0" with a 24-bit prefix (network section).

This new network address section (originally part of the host address) made possible by the subnet mask is referred to as the subnet address.



Note When you enter the subnet mask, be sure to set the DHCP setting to Off.

- 1 Press \triangleright while `>TCP/IP On >` is displayed.
- 2 Press \triangle or ∇ repeatedly until `>>Subnet Mask` appears.
- 3 Press **[OK]**. A blinking cursor (`_`) appears.

```
>>Subnet Mask
  000.000.000.000
```

- 4 Press \triangle or ∇ to increase or decrease, respectively, the value at the blinking cursor. You can set any value between 000 and 255. Use \triangleleft and \triangleright to move the cursor right and left.
- 5 Display the desired subnet mask and press **[OK]**.
- 6 Press **[MENU]**. The display returns to Ready.

Gateway (Gateway setting)

Gateway generally refers to a protocol conversion device used to allow networks with differing protocol systems to interconnect.

For example, a "Gateway" device is required to connect a different closed network (using its own protocols) to the open Internet (using TCP/IP).

By installing a gateway, the communications protocols and data display modes on different networks can be made compatible.

On TCP/IP networks, the term gateway is used to refer to routers.



Note Before you input the gateway, be sure to set the DHCP setting to Off.

- 1 Press \triangleright while `>TCP/IP On >` is displayed.
- 2 Press \triangle or ∇ repeatedly until `>>Gateway` appears.
- 3 Press **[OK]**. A blinking cursor (`_`) appears.

```
>>Gateway
  000.000.000.000
```

- 4 Press \triangle or ∇ to increase or decrease, respectively, the value at the blinking cursor. You can set any value between 000 and 255. Use \triangleleft and \triangleright to move the cursor right and left.
- 5 Display the desired gateway and press **[OK]**.

- 6 Press **[MENU]**. The display returns to *Ready*.

Bonjour (Bonjour setting)

Bonjour, also known as zero-configuration networking, is a service that automatically detects computers, devices and services on an IP network.

Bonjour, because an industry-standard IP protocol is used, allows devices to automatically recognize each other without an IP address being specified or DNS server being set.

Bonjour also sends and receives network packets by UDP port 5353. If a firewall is enabled, the user must check that UDP port 5353 is left open so that Bonjour will run correctly. Some firewalls are set up so as to reject only certain Bonjour packets. If Bonjour does not run stably, check the firewall settings and ensure that Bonjour is registered on the exceptions list and that Bonjour packets are accepted. If you install Bonjour on Windows XP Service Pack 2 or later, the Windows firewall will be set up correctly for Bonjour.

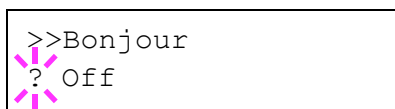

- 1 Press \triangleright while *>TCP/IP On >* is displayed.
- 2 Press \triangle or ∇ repeatedly until *>>Bonjour* appears.
- 3 Press **[OK]**. A blinking cursor ($_$) appears.

- 4 Select *On* or *Off* using \triangle or ∇ .

- 5 Press **[OK]**.

- 6 Press **[MENU]**. The display returns to *Ready*.

TCP/IP (IPv6) (IPv6 settings)

This selects the settings for TCP/IP (IPv6).

TCP/IP (IPv6) is based on the current Internet protocol, TCP/IP (IPv4). IPv6 is the next-generation Internet protocol and expands the available address space, which resolves the problem of the lack of addresses under IPv4, while also introducing other improvements such as additional security functionality and the capacity to prioritize data transmission.

The options available in the TCP/IP (IPv6) settings are as follows:

- RA(Stateless) (RA (Stateless) setting)
- DHCPv6 (DHCPv6 setting)

IMPORTANT The RA (Stateless) and DHCPv6 menu options for TCP/IP (IPv6) are displayed when TCP/IP (IPv6) is enabled.

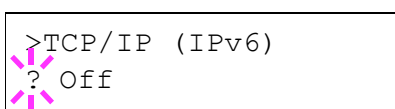

- 1 Press \triangleright while *Network >* is displayed.
- 2 Press \triangle or ∇ repeatedly until *>TCP/IP (IPv6) >* appears.
- 3 Press **[OK]**. A blinking question mark (?) appears.

- 4 Select *On* or *Off* using \triangle or ∇ .

- 5 Select *On* and press **[OK]**. The display changes to the settings shown below.

RA(Stateless) (RA (Stateless) setting)

The IPv6 router communicates (transmits) information such as the global address prefix using ICMPv6. This information is the Router Advertisement (RA).

ICMPv6 stands for Internet Control Message Protocol, and is a IPv6 standard defined in the RFC 2463 "Internet Control Message Protocol (ICMPv6) for the Internet Protocol Version 6 (IPv6) Specification".

- 1 Press \triangleright while `>TCP/IP (IPv6) On >` is displayed.
- 2 Press \triangle or ∇ repeatedly until `>>RA(Stateless)` appears.
- 3 Press **[OK]**. A blinking question mark (?) appears.

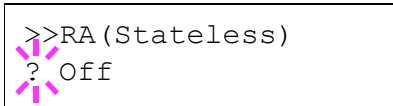

- 4 Select `On` or `Off` using \triangle or ∇ .
- 5 Press **[OK]**.
- 6 Press **[MENU]**. The display returns to `Ready`.

DHCPv6 (DHCPv6 setting)

DHCPv6 is the next-generation of the Internet's Dynamic Host Configuration Protocol and supports IPv6. It extends the BOOTP startup protocol that defines the protocols used for transferring configuration information to hosts on the network.

DHCPv6 permits the DHCP server to use its expanded functionality to send configuration parameters to an IPv6 node. Because the network addresses that can be used are allocated automatically, the IPv6 node management workload is reduced in systems where the administrator has to exercise close control over IP address allocation.

- 1 Press \triangleright while `>TCP/IP (IPv6) On >` is displayed.
- 2 Press \triangle or ∇ repeatedly until `>>DHCPv6` appears.
- 3 Press **[OK]**. A blinking question mark (?) appears.

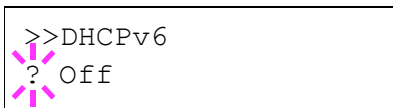

- 4 Select `On` or `Off` using \triangle or ∇ .
- 5 Press **[OK]**.
- 6 Press **[MENU]**. The display returns to `Ready`.

Device Common (Selecting/Setting the common device)

Selects/sets all the functions in this printer.

The options available in Device Common are as follows:

- MSG Language (Selecting the message language)
- Buzzer (Alarm (Buzzer) setting)
- RAM Disk Mode (Using the RAM disk)
- Memory Card (Using the CF card)
- Error Handling (Error detection setting)
- Timer (Timer setting)

1 Press **[MENU]**.

2 Press Δ or ∇ repeatedly until `Device Common >` appears.



```
Device Common >
```

MSG Language (Selecting the message language)

You can select the language of the message display by following the procedure given below. You can optionally download messages in other languages. Contact your service representative for information.

1 Press \triangleright while `Device Common >` is displayed.

2 Press Δ or ∇ repeatedly until `>MSG Language` appears. The default message language is `English`.

3 To change the language, press **[OK]**. A blinking question mark (?) appears.

4 Press Δ or ∇ . The display cycles through the available selection in the following order:

```
English  
Français  
Deutsch  
Italiano  
Nederlands  
Español  
Русский  
Português
```

5 Press **[OK]**.

6 Press **[MENU]**. The display returns to `Ready`.

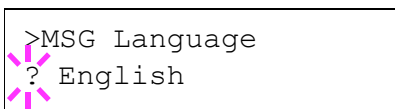

```
>MSG Language  
? English
```

Buzzer (Alarm (Buzzer) setting)

This function uses tones to notify the user of printer operations and the printer status. This setting is useful, for example, when the printer is located some distance from the user.

The options available in Buzzer are as follows:

- Key Confirm. (Key confirmation tone setting)
- Job End (Job completed tone setting)
- Ready (Preparation completed tone setting)
- Error (Error tone setting)

1 Press \triangleright while `Device Common >` is displayed.

2 Press \triangle or ∇ repeatedly until `>Buzzer >` appears.

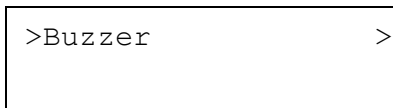

```
>Buzzer >
```

Key Confirm. (Key confirmation tone setting)

When `On` is selected in this setting, a tone sounds each time a key is used. The default setting is `On`.

1 Press \triangleright while `>Buzzer >` is displayed.

2 Press \triangle or ∇ repeatedly until `>>Key Confirm.` appears.

3 Press **[OK]**. A blinking question mark (?) appears.

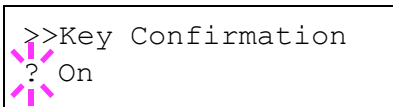

```
>>Key Confirmation  
? On
```

4 Select `On` or `Off` using \triangle or ∇ .

5 Press **[OK]**.

6 Press **[MENU]**. The display returns to `Ready`.

Job End (Job completed tone setting)

When `On` is selected in this setting, a tone sounds when printing ends. The default setting is `Off`.

1 Press \triangleright while `>Buzzer >` is displayed.

2 Press \triangle or ∇ repeatedly until `>>Job End` appears.

3 Press **[OK]**. A blinking question mark (?) appears.

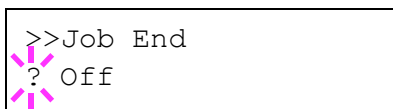

```
>>Job End  
? Off
```

4 Select `On` or `Off` using \triangle or ∇ .

5 Press **[OK]**.

6 Press **[MENU]**. The display returns to `Ready`.

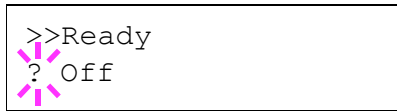

Ready (Preparation completed tone setting)

When **On** is selected in this setting, a tone sounds when print preparation has been completed. The default setting is **Off**.

- 1 Press **▷** while **>Buzzer >** is displayed.
- 2 Press **△** or **▽** repeatedly until **>>Ready** appears.
- 3 Press **[OK]**. A blinking question mark (?) appears.

4 Select **On** or **Off** using **△** or **▽**.

5 Press **[OK]**.

6 Press **[MENU]**. The display returns to **Ready**.

Error (Error tone setting)

When **On** is selected in this setting, a tone sounds when a problem such as running out of paper or a paper jam occurs during printing. The default setting is **On**.

- 1 Press **▷** while **>Buzzer >** is displayed.
- 2 Press **△** or **▽** repeatedly until **>>Error** appears.
- 3 Press **[OK]**. A blinking question mark (?) appears.

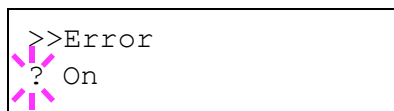

4 Select **On** or **Off** using **△** or **▽**.

5 Press **[OK]**.

6 Press **[MENU]**. The display returns to **Ready**.

RAM Disk Mode (Using the RAM disk)

The RAM disk is a memory space shared within the printer memory that can temporarily store print jobs. The stored print job can then be used to print multiple copies of the job reducing the total amount of time required to print the whole job.

To use the RAM disk, activate and enter the desired size of the RAM disk in the manner described below. The maximum RAM disk size can be calculated as follows:

When the RAM disk is activated = The maximum RAM disk size is 4MB (when no options are attached)

When the optional memory is installed = The maximum RAM disk size is 1/2 of the total optional memory installed

To activate RAM disk in the printer's memory, first you must set the RAM disk mode to `On` and set the desired data size for the RAM disk as described in the following section. This allows you to perform the following operations on the RAM disk.



Note The printer also supports CF card as a storage device. The CF card is installed into the dedicated slot of the printer. The RAM disk is an allocated part of the printer's memory.

IMPORTANT The RAM disk stores data only temporarily. When the printer is reset or turned off, the stored data will be erased.

The RAM disk is allocated from the printer memory available to users. If the size of the RAM disk is set too large, the printing speed may decrease or the memory may become insufficient.

- 1 Press `>` while `Device Common >` is displayed.
- 2 Press `△` or `▽` repeatedly until `>RAM Disk Mode >` appears.
- 3 Press **[OK]**. A blinking question mark (?) appears.
- 4 Select `On` or `Off` using `△` or `▽`.
- 5 Press **[OK]**.
- 6 Press **[MENU]**. The display returns to `Ready`.

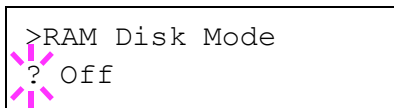

```
>RAM Disk Mode
? Off
```

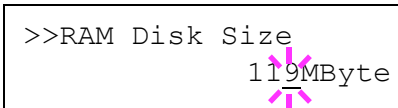

>>RAM Disk Size
119MByte

RAM Disk Size (Setting the RAM disk size)

Use this procedure to set the amount of memory used for the RAM disk.

IMPORTANT The RAM Disk Size menu option only appears when RAM Disk Mode is set to On.

- 1 Press \triangleright while >RAM Disk Mode On > is displayed.
- 2 Press **[OK]**. The message display shows a blinking cursor ($_$). Press \triangle or ∇ to display the desired size. Definable RAM disk size is 001 to 512. Use \triangleleft and \triangleright to move the cursor right and left.

This range varies depending on the total memory size of the printer. The setting exceeding this range is automatically adjusted to the maximum RAM disk size.

- 3 When the desired RAM disk size is displayed, press **[OK]**.
- 4 Press **[MENU]**. The display returns to Ready. Turn the printer off and then on again. The selected RAM disk size is activated after the printer is restarted.

Memory Card (Using the CF card)

The printer is equipped with a slot for a CF card (memory card). By inserting a CF card into the printer, the following operations become available.

- Format (Formatting CF card)

For details about the handling of the CF card, refer to **CompactFlash (CF) Card** on page 3-6.

IMPORTANT The Memory Card menu options are only displayed when a CF card is installed in the printer.

- 1 Press \triangleright while Device Common > is displayed.
- 2 Press \triangle or ∇ repeatedly until >Memory Card > appears.

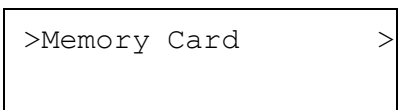

>Memory Card >

Format (Formatting CF card)

A new CF card must be formatted before it can be used in the printer. Formatting allows data to be written to the CF card..

IMPORTANT Format is only displayed when a CF card is installed in the printer and protection is disabled.



Note Format is only displayed when a CF card is installed in the printer and protection is disabled.

Formatting will destroy any existing data on a storage device including a used CF card.

Formatting of the CF card must be executed from the printer.

When a new CF card is inserted in the printer's slot, `Format error Memory card` will appear on the message display.

- 1 Press `>` while `>Memory Card >` is displayed.
- 2 `>>Format` appears.
- 3 Press **[OK]**. A question mark (?) appears.

`>>Format ?`

- 4 Press **[OK]**.

`Processing` appears and formatting of the CF card starts. When the formatting is successfully completed, the display returns to `Ready`.

Error Handling (Error detection setting)

This specifies the settings for the detection methods used for duplex printing errors and for paper size and paper type errors when the paper source is fixed.

The options available in Error Handling are as follows:

- Duplex (Duplex printing error detection setting)
- Paper Mismatch (Detection settings for paper size/type errors when the paper source is fixed)
- MP Tray Empty (Warning when the MP tray is empty)

- 1 Press `>` while `Device Common >` is displayed.
- 2 Press `△` or `▽` repeatedly until `>Error Handling >` appears.

`>Error Handling >`

Duplex (Duplex printing error detection setting)

If the error detection setting for duplex printing has been turned **On**, and you attempt to print onto a paper size and paper type that cannot be used for duplex printing, the **Duplex disabled Press GO** error message will be displayed and printing will stop.

| | |
|------------|--|
| On | <ul style="list-style-type: none">To print onto one-side of the paper only when this message is displayed, press [GO].Press [Cancel] to cancel the printing itself. |
| Off | <ul style="list-style-type: none">To print onto one-side of the paper. |

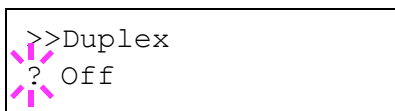

- 1 Press **▷** while **>Error Handling >** is displayed.
- 2 Press **△** or **▽** repeatedly until **>>Duplex** appears.
- 3 Press **[OK]**. A blinking question mark (?) appears.

- 4 Select **On** or **Off** using **△** or **▽**.
- 5 Press **[OK]**.
- 6 Press **[MENU]**. The display returns to **Ready**.

Paper Mismatch (Detection settings for paper size/type errors when the paper source is fixed)

Turn this setting to **Off** if you want to continue printing even if the paper size or type you specified is different from the fixed paper source, or turn it to **On** to have the paper feed error displayed.

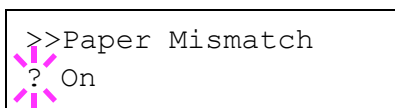

- 1 Press **▷** while **>Error Handling >** is displayed.
- 2 Press **△** or **▽** repeatedly until **>>Paper Mismatch** appears.
- 3 Press **[OK]**. A blinking question mark (?) appears.

- 4 Select **On** or **Off** using **△** or **▽**.
- 5 Press **[OK]**.
- 6 Press **[MENU]**. The display returns to **Ready**.

MP Tray Empty (Warning when the MP tray is empty)

Turn this setting to **On** if you want the error displayed when the MP tray is configured as the default paper source, and there is no paper in the MP tray, or turn it to **Off** not to have the error displayed.

The setting **On** enables the paper-empty message to display when the MP tray is empty.

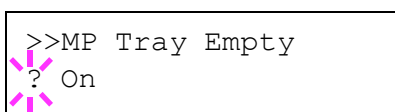

- 1 Press **▷** while **>Error Handling >** is displayed.
- 2 Press **△** or **▽** repeatedly until **>>MP Tray Empty** appears.
- 3 Press **[OK]**. A blinking question mark (?) appears.

- 4 Select **On** or **Off** using **△** or **▽**.
- 5 Press **[OK]**.

6 Press **[MENU]**. The display returns to Ready.

Timer (Timer setting)

This specifies timer-related settings such as the automatic form-feed timeout and the timeout settings for Auto Sleep.

The options available in Timer are as follows:

- Form Feed Time Out (Automatic form feed timeout setting)
- Sleep Timer (Sleep timer timeout time)
- Auto Error Clear (Auto error clear setting)
- Error Clear Timer (Setting the error clear time)
- Auto Panel Reset (Auto panel reset settings)
- Panel Reset Timer (Setting the panel reset timer)
- Auto Sleep (Setting the sleep timer)



>Timer >

- 1** Press \triangleright while `Device Common >` is displayed.
- 2** Press \triangle or ∇ repeatedly until `>Timer >` appears.

Form Feed Time Out (Automatic form feed timeout setting)

If the printer receives no data for a certain period, it will time out and release the current interface. It prints whatever data it has in its buffer and feeds out the page. The default form feed timeout time is 30 seconds.

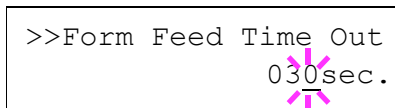

>>Form Feed Time Out
030sec.

- 1** Press \triangleright while `>Timer >` is displayed.
- 2** Press \triangle or ∇ repeatedly until `>>Form Feed Time Out` appears.
- 3** Press **[OK]**. A blinking cursor ($_$) appears.
- 4** Press \triangle or ∇ to increase or decrease the value at the blinking cursor and set the desired time. The timeout time can be between 5 and 495 seconds, in 5-second increments. Use \triangleleft and \triangleright to move the cursor right and left.
- 5** Press **[OK]**.
- 6** Press **[MENU]**. The display returns to `Ready`.

Sleep Timer (Sleep timer timeout time)

You can adjust the length of time the printer waits before entering Auto Sleep in the absence of data.

The printer reverts to normal operation mode when the printer receives a print job, the operation panel is operated, or one of the exterior covers is opened. The default time is 15 minutes.



Note Calibration is automatically executed before the printer reverts to normal operation mode.

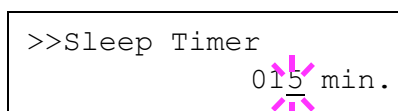

- 1 Press \triangleright while `>Timer >` is displayed.
- 2 Press \triangle or ∇ repeatedly until `>>Sleep Timer` appears.
- 3 To change the timeout time, press **[OK]**. A blinking cursor (\ast) appears.
- 4 Press \triangle or ∇ to increase or decrease the value at the blinking cursor and set the desired time. The timer can be set between 1 and 240 minutes. Use \triangleleft and \triangleright to move the cursor right and left.
- 5 Press **[OK]**.
- 6 Press **[MENU]**. The display returns to `Ready`.

Auto Error Clear (Auto error clear setting)

If an error that still allows you to continue printing occurs, the next received data is automatically printed after a set period of time elapses. For example, if the printer is shared over a network as a network printer and one person causes one of the above errors, after the set period of time elapses, the data sent from the next person is printed. The default setting is `Off` (Auto Error Clear disabled).

The auto clear errors are:

- Memory overflow Press GO
- Print overrun Press GO
- KPDL error ## Press GO
- RAM disk error## Press GO
- MemoryCard err## Press GO
- Duplex disabled Press GO
- No multi copies Press GO
- USB memory err## Press GO

For setting the auto error clear recovery time, refer to the next section **Error Clear Timer (Setting the error clear time)**.

- 1 Press `▷` while `>Timer >` is displayed.
- 2 Press `△` or `▽` repeatedly until `>>Auto Error Clear` appears.
- 3 Press **[OK]**. A blinking question mark (?) appears.

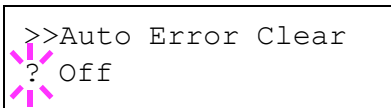

```
>>Auto Error Clear
? Off
```

- 4 Select `On` or `Off` using `△` or `▽`.
- 5 Press **[OK]**.
- 6 Press **[MENU]**. The display returns to `Ready`.

Error Clear Timer (Setting the error clear time)

If `Auto Error Clear` is set to `On` and a non-fatal error (an error that allows printing to continue) occurs, this setting specifies the time until the error is recovered and printing resumes. The default time is 30 seconds.

- 1 Press `▷` while `>Timer >` is displayed.
- 2 Press `△` or `▽` repeatedly until `>>Error Clear Timer` appears.
- 3 Press **[OK]**. A blinking cursor (`_`) appears.

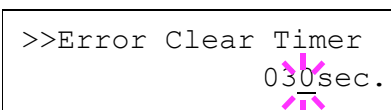

```
>>Error Clear Timer
030sec.
```

- 4 Press `△` or `▽` to increase or decrease the value at the blinking cursor and set the desired time. The time must be set between 5 and 495 seconds, in 5-second increments. You can use `◀` and `▶` to move the cursor right and left.
- 5 Press **[OK]**.
- 6 Press **[MENU]**. The display returns to `Ready`.

Auto Panel Reset (Auto panel reset settings)

The Auto Panel Reset function automatically restores the default settings if the panel is not used for a set time. The default setting is `On`.

For setting the time until the panel is reset, refer to the next section **Panel Reset Timer (Setting the panel reset timer)**.

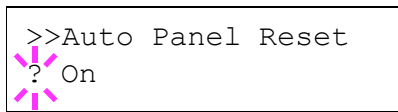

- 1 Press \triangleright while `>Timer >` is displayed.
- 2 Press \triangle or ∇ repeatedly until `>>Auto Panel Reset` appears.
- 3 Press **[OK]**. A blinking question mark (?) appears.
- 4 Select `On` or `Off` using \triangle or ∇ .
- 5 Press **[OK]**.
- 6 Press **[MENU]**. The display returns to `Ready`.

Panel Reset Timer (Setting the panel reset timer)

When Auto Panel Reset is set to `On`, this sets the time until the panel is automatically reset after the user stops using the panel. The default time is 90 seconds.

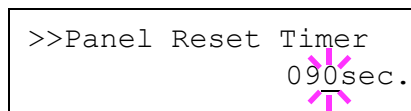

- 1 Press \triangleright while `>Timer >` is displayed.
- 2 Press \triangle or ∇ repeatedly until `>>Panel Reset Timer` appears.
- 3 Press **[OK]**. The message display shows a blinking cursor (`_`).
- 4 Press \triangle or ∇ to increase or decrease the value at the blinking cursor and set the desired time. The time must be set between 005 and 495 seconds, in 5-second increments. Use \triangleleft and \triangleright to move the cursor right and left.
- 5 Press **[OK]**.
- 6 Press **[MENU]**. The display returns to `Ready`.

Auto Sleep (Setting the sleep timer)

The printer has a sleep timer that is used to conserve power when the printer is not printing, processing, or receiving data. The default setting is `On`.

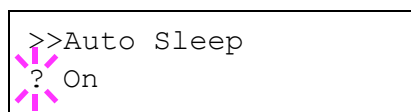

- 1 Press \triangleright while `>Timer >` is displayed.
- 2 Press \triangle or ∇ repeatedly until `>>Auto Sleep` appears.
- 3 To turn off the sleep timer, press **[OK]**. A blinking question mark (?) appears.
- 4 Select `On` or `Off` using \triangle or ∇ .
- 5 Press **[OK]**. The sleep timer is turned off.
- 6 Press **[MENU]**. The display returns to `Ready`.

Security

The security functions can be set up to protect printer operation and the print data.

The options available in Security are as follows:

- ID (Administrator ID input)
- Password (Administrator password input)
- I/F Block (Interface (external device) block setting)
- NetWare (NetWare setting)
- AppleTalk (AppleTalk setting)
- IPP (IPP setting)
- SSL Server (SSL Server setting)
- IPSec (IPSec setting)
- Security Level (Security level setting)



- 1** Press **[MENU]**.
- 2** Press Δ or ∇ repeatedly until `Security >` appears.

ID (Administrator ID input)

To use the Security function, you must enter an administrator ID. For information on how to set the administrator ID, refer to **Admin (Administrator settings)** on page **2-65**.



- 1** Press \triangleright while `Security >` is displayed.
- 2** The message display shows `ID` and a blinking cursor (`_`).
- 3** Press Δ or ∇ to increase or decrease, respectively, the value at the blinking cursor. Enter the specified ID. Use \triangleleft and \triangleright to move the cursor right and left. Enter an ID consisting of between 1 and 16 numbers.
- 4** Press **[OK]**. Proceed to the next step *Password (Administrator Password input)*.

Password (Administrator Password input)

To set up the Security functions, you must enter an administrator ID and administrator password. For information on how to set the administrator password, refer to **Admin (Administrator settings)** on page 2-65.

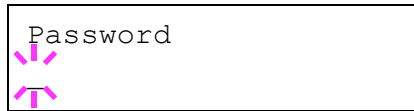

- 1 When you entered the ID in the previous step (ID (Administrator ID input)), the message display shows `Password` (Administrator password input) and a blinking cursor (`_`).
- 2 Press Δ or ∇ to increase or decrease, respectively, the value at the blinking cursor. Enter the specified password. Use \triangleleft and \triangleright to move the cursor right and left. Enter a password consisting of between 0 (no settings) and 16 numbers.



Note If you enter an incorrect administrator ID or password, the message `Wrong ID` or `Wrong Password` appears and the input screen then reappears. Re-enter the password correctly.

- 3 Press **[OK]**. The Security screen appears.

Interface Block (Interface (external device) block setting)

You can use this to lock and thereby protect the interface. The options available in Interface Block are as follows:

- USB Host (USB memory slot setting)
- USB Device (USB interface setting)



- 1 After entering the administrator ID and password, press Δ or ∇ repeatedly until `>I/F Block >` appears.

USB Host (USB memory slot setting)

This locks and protects the USB memory slot (USB host). The default setting is `Unblock`.

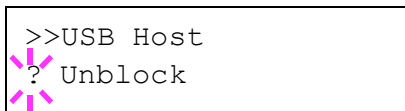

- 1 Press \triangleright while `>I/F Block >` is displayed. `>>USB Host` appears.
- 2 Press **[OK]**. A blinking question mark (?) appears.
- 3 Select `Block` or `Unblock` using Δ or ∇ .
- 4 Press **[OK]**.
- 5 Press **[MENU]**. The display returns to `Ready`.

USB Device (USB interface setting)

This locks and protects the USB interface. The default setting is Unblock.

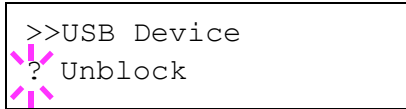

- 1** Press **▷** while **>I/F Block >** is displayed. **>>USB Device** appears.
- 2** Press **[OK]**. A blinking question mark (?) appears.
- 3** Select **Block** or **Unblock** using **△** or **▽**.
- 4** Press **[OK]**.
- 5** Press **[MENU]**. The display returns to **Ready**.

NetWare (NetWare setting)

NetWare is a PC-based network operating system specifically for servers.

NetWare is a client-server system that operates by installing the NetWare OS on the server and dedicated client modules (NetWare clients) on the client machines (running MS-DOS, OS/2, Windows, etc.). The basic network layer protocol used is NetWare's own IPX (Internetwork Packet eXchange)/SPX (Sequenced Packet eXchange), but the system also supports TCP/IP.

The feature of the NetWare OS is that it is specifically for servers, unlike general-purpose operating systems such as Windows NT and UNIX. Only the minimum required for server operation can be performed from the NetWare OS console on the server. Server and file management is basically carried out using management tools from the clients. Also, all drivers and protocol stacks are in the form of modules called NetWare Loadable Modules (NLMs), and the ability of NLMs to load and unload flexibly and dynamically is a major advantage of this system.

The default setting is `On`.



Note Check with your network administrator when selecting network settings.

```
>NetWare >
```

```
>NetWare >  
? On
```

- 1 After entering the administrator ID and password, press Δ or ∇ repeatedly until `>NetWare >` appears.
- 2 Press **[OK]**. A blinking question mark (?) appears.
- 3 Select `On` or `Off` using Δ or ∇ .
- 4 Press **[OK]**.
- 5 Press **[MENU]**. The display returns to `Ready`.

Frame Type (Frame type setting)

Sets the NetWare frame type. Frame is a term referring to a set of data that flows through the network. The default setting is `Auto`.

```
>>Frame Type  
? Auto
```

- 1 Press \triangleright while `>NetWare On >` is displayed. `>>Frame Type` appears.
- 2 Press **[OK]**. A blinking question mark (?) appears.
- 3 Press Δ or ∇ until the desired frame type appears and then press **[OK]**. The message display toggles through the following types:
 - `Auto`
 - `802.3`
 - `Ethernet-II`
 - `802.2`
 - `SNAP`
- 4 Press **[OK]**.
- 5 Press **[MENU]**. The display returns to `Ready`.

AppleTalk (AppleTalk setting)

AppleTalk is a communications protocol used primarily on Macintosh computers and also refers to the Mac OS network functions.

AppleTalk assigns 24-bit network addresses (a 16-bit network section and an 8-bit node address) that are used to identify devices (computers, printers, etc.) on the network.

When the power is turned on, a broadcast signal is sent out onto the network and the addresses and machine names are automatically assigned.

The default setting is *On*.



Note Check with your network administrator when selecting network settings.

```
>AppleTalk
```

```
>AppleTalk
? On
```

- 1 After entering the administrator ID and password, press Δ or ∇ repeatedly until `>AppleTalk` appears.
- 2 Press **[OK]**. A blinking question mark (?) appears.
- 3 Select *On* or *Off* using Δ or ∇ .
- 4 Press **[OK]**.
- 5 Press **[MENU]**. The display returns to *Ready*.

IPP (IPP setting)

IPP (Internet Printing Protocol) is a standard that uses TCP/IP networks such as the Internet to enable print jobs to be sent between remote computers and printers.

IPP is an extension of the HTTP protocol used to view websites and enables printing to be carried out via routers on printers in remote locations. It also supports the HTTP authentication mechanisms along with SSL server and client authentication as well as encryption.

The default setting is *Off*.



Note Check with your network administrator when selecting network settings.

```
>IPP
```

```
>IPP
? Off
```

- 1 After entering the administrator ID and password, press Δ or ∇ repeatedly until `>IPP` appears.
- 2 Press **[OK]**. A blinking question mark (?) appears.
- 3 Select *On* or *Off* using Δ or ∇ .
- 4 Press **[OK]**.
- 5 Press **[MENU]**. The display returns to *Ready*.

SSL Server (SSL Server setting)

SSL (Secure Sockets Layer) refers to a protocol used to encrypt information sent and received over a network. SSL can currently be used to encrypt data such as the WWW or FTP files widely used on the Internet so that privacy-related information, credit card numbers, corporate secrets and other confidential information can be sent and received safely.

SSL servers use this protocol to authenticate servers and clients.

The default setting is *Off*.



Note Check with your network administrator when selecting network settings.

```
>SSL Server >
```

```
>SSL Server  
? Off
```

- 1 After entering the administrator ID and password, press Δ or ∇ repeatedly until `>SSL Server >` appears.
- 2 Press **[OK]**. A blinking question mark (?) appears.
- 3 Select *On* or *Off* using Δ or ∇ .
- 4 Press **[OK]**.
- 5 Press **[MENU]**. The display returns to *Ready*.

DES (SSL Server DES setting)

DES (Data Encryption Standard) is a typical symmetric-key cryptographic algorithm that divides data in to 64-bit blocks and then encrypts each block using a 56-bit key.



Note Symmetric-key cryptography, because it uses the same key for both encryption and decryption, uses the same key in both directions when encrypted data is exchanged. Accordingly, to prevent the key from being divulged, key transfer and storage must be very strictly managed.

The default setting is *Off*.

```
>>DES  
? Off
```

- 1 Press \triangleright while `>SSL Server On >` is displayed. `>>DES` appears.
- 2 Press **[OK]**. A blinking question mark (?) appears.
- 3 Select *On* or *Off* using Δ or ∇ .
- 4 Press **[OK]**.
- 5 Press **[MENU]**. The display returns to *Ready*.



3DES (SSL Server 3DES setting)

3DES (Triple Data Encryption Standard) is a high level of encryption in which DES encryption is repeated threefold.

The default setting is *Off*.

- 1 Press **▷** while **>SSL Server On >** is displayed. **>>3DES** appears.
- 2 Press **[OK]**. A blinking question mark (?) appears.

- 3 Select *On* or *Off* using **△** or **▽**.

- 4 Press **[OK]**.

- 5 Press **[MENU]**. The display returns to *Ready*.

AES (SSL Server AES setting)

AES (Advanced Encryption Standard) was developed to replace DES as the standard encryption as the safety of DES has declined. AES is a block encryption system that uses 128-bit blocks and an SPN structure (a typical structure for repeated encryption) with three selectable key lengths of 128, 192 and 256 bits.

The default setting is *Off*.

- 1 Press **▷** while **>SSL Server On >** is displayed. **>>AES** appears.

- 2 Press **[OK]**. A blinking question mark (?) appears.

- 3 Select *On* or *Off* using **△** or **▽**.

- 4 Press **[OK]**.

- 5 Press **[MENU]**. The display returns to *Ready*.



IPP over SSL (SSL Server IPP over SSL setting)

IPP over SSL is an encryption function that uses SSL for communications between users and servers in network printing. To use IPP over SSL, both server and client must support the protocol.

The default setting is *Off*.

- 1 Press **▷** while **>SSL Server On >** is displayed. **>>IPP over SSL** appears.

- 2 Press **[OK]**. A blinking question mark (?) appears.

- 3 Select *On* or *Off* using **△** or **▽**.

- 4 Press **[OK]**.

- 5 Press **[MENU]**. The display returns to *Ready*.

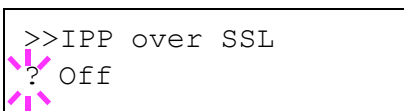

HTTPS (SSL Server HTTPS setting)

HTTPS (HyperText Transfer Protocol Secure) is a protocol that adds SSL data encryption, message authentication and a digital signature function to the HTTP protocol used for data transfer between WWW servers and clients.

S-HTTP is a similar protocol, but HTTPS differs in that it uses SSL.

The default setting is *Off*.



```
>>HTTPS
? Off
```

1 Press **>** while *>SSL Server On >* is displayed. *>>HTTPS* appears.

2 Press **[OK]**. A blinking question mark (?) appears.

3 Select *On* or *Off* using **△** or **▽**.

4 Press **[OK]**.

5 Press **[MENU]**. The display returns to *Ready*.

IPSec (IPSec setting)

IPSec (IP Security Protocol) is a security protocol adopted as the standard by the IETF for authentication and encryption in the third network layer (IP layer).

It can be used with both IPv4 and IPv6.



Note IPv4 uses 32-bit IP addresses and IPv6 uses 128-bit IP addresses.

The default setting is *Off*.



Note Check with your network administrator when selecting network settings.



```
>IPSec
```



```
>IPSec
? Off
```

1 After entering the administrator ID and password, press **△** or **▽** repeatedly until *>IPSec* appears.

2 Press **[OK]**. A blinking question mark (?) appears.

3 Select *On* or *Off* using **△** or **▽**.

4 Press **[OK]**.

5 Press **[Menu]**. The display returns to *Ready*.

Security Level (Security level setting)

Security Level is primarily a menu used by service representative for maintenance work. There is no need for customers to use this menu.

Admin (Administrator settings)

The administrator setting is a function that identifies the user who can use the printer and can be used to manage users. The administrator is authenticated by the entered administrator ID and password and can then use the printer's security functions.

The options available in Admin are as follows:

- ID (Administrator ID input)
- Password (Administrator password input)
- Change ID (Administrator ID change)
- Change Password (Administrator password change)

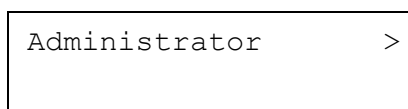

- 1** Press **[MENU]**.
- 2** Press Δ or ∇ repeatedly until `Admin >` appears.

ID (Administrator ID input)

You can use this to set the administrator ID. The default setting is the numeric part of your printer's model name. The default setting is "3500".



- 1** Press \triangleright while `Admin >` is displayed.
- 2** The message display shows `ID` and a blinking cursor (`_`).
- 3** Press Δ or ∇ to increase or decrease, respectively, the value at the blinking cursor. Enter the specified ID. Use \triangleleft and \triangleright to move the cursor right and left. Enter an ID consisting of between 1 and 16 numbers.
- 4** Press **[OK]**. Proceed to the next step *Password (Administrator Password input)*.

Password (Administrator Password input)

You can use this to set the administrator password. The default setting is the numeric part of your printer's model name. The default setting is "3500".



- 1** When you entered the ID in the previous step (ID (Administrator ID input)), the message display shows `Password` (Administrator password input) and a blinking cursor (`_`).
- 2** Press Δ or ∇ to increase or decrease, respectively, the value at the blinking cursor. Enter the specified password. Use \triangleleft and \triangleright to move the cursor right and left. Enter a password consisting of between 0 and 16 numbers.



Note If you enter the incorrect administrator ID or password, the `Wrong ID` or `Wrong Password` message appears and the input screen then reappears. Re-enter the ID or password correctly.

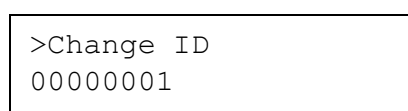

- 3** Once you enter the correct ID and password, the *Admin (change)* screen appears. (E.g.: Where the administrator ID is 00000001)

Adjust/Maintenance (Adjust/Maintenance selection/setting)

Adjust/Maintenance is used to adjust the print quality and to carry out printer maintenance.

The options available in Adjust/Maintenance are as follows:

- Restart Printer
- Service (for maintenance)

IMPORTANT *Service* is primarily a menu used by service representative for maintenance work. There is no need for customers to use this menu.

- 1** Press **[MENU]**.
- 2** Press Δ or ∇ repeatedly until `Adjust/Maintenance >` appears.

```
Adjust/Maintenance >
```

Restart Printer

The procedure described below resets the printer's temporary conditions, such as the current page orientation, font, etc., set by commands to their default values. Downloaded fonts and macros are deleted from the printer's memory.

- 1** Press \triangleright while `Adjust/Maintenance >` is displayed.
- 2** Press Δ or ∇ repeatedly until `>Restart Printer` appears.
- 3** Press **[OK]**. A question mark (?) appears.

```
>Restart Printer ?
```

- 4** Press **[OK]** again. `Self test` appears while the printer is resetting itself, followed by `Ready`.

Service (for maintenance)

The options available in Service are as follows:

- Print Status Page (Printing the service status page)
- Print Network Status Page (Printing the network status page)
- Print Test Page
- Developer (Initializing the developer unit)

IMPORTANT *Service* is primarily a menu used by service representative for maintenance work. There is no need for customers to use this menu.

- 1 Press \triangleright while *Adjust/Maintenance >* is displayed.
- 2 Press \triangle or ∇ repeatedly until *>Service >* appears.



```
>Service >
```

Print Status Page (Printing the service status page)

The service status page contains printer settings information that is more detailed than the standard status page and is therefore mostly for service purposes. However, there is a great deal of information on the service status page that may be useful to you.

- 1 Press \triangleright while *>Service >* is displayed.
- 2 Press \triangle or ∇ repeatedly until *>>Print Status Page* appears.
- 3 Press **[OK]**. A question mark (?) appears.

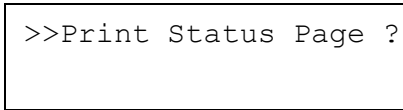

```
>>Print Status Page ?
```

- 4 Press **[OK]** again. *Processing* appears and a service status page is printed out.
- 5 When printing ends, the display returns to *Ready*.

Print Network Status Page (Printing the network status page)

The network status page contains detailed information on the network settings. This is primarily used for maintenance by service representative, but it contains information that may also be useful to you.

- 1 Press \triangleright while *>Service >* is displayed.
- 2 Press \triangle or ∇ repeatedly until *>>Print Network Status Page* appears.
- 3 Press **[OK]**. A question mark (?) appears.



```
>>Print  
Network Status Page?
```

- 4 Press **[OK]** again. *Processing* appears and a network status page is printed out.
- 5 When printing ends, the display returns to *Ready*.

Print Test Page

The test page is printed to check the effectiveness of printer adjustments. This is primarily used for maintenance by service representative, but it contains information that may also be useful to you.

- 1 Press \triangleright while *>Service >* is displayed.

>>Print Test Page ?

- 2** Press Δ or ∇ repeatedly until >>Print Test Page appears.
- 3** Press **[OK]**. A question mark (?) appears.
- 4** Press **[OK]** again. Processing appears and a test page is printed out.
- 5** When printing ends, the display returns to Ready.

Developer (Initializing the developer unit)

The replaced developer can be automatically fill up the toner using this menu when a toner container is installed and the printer is turned on. This is primarily used for maintenance by service representative.

3 Option

This chapter explains the options for this printer.

| | |
|---------------------------------|------------|
| General Information | 3-2 |
| Expansion Memory Modules | 3-3 |
| Paper Feeder (PF-100) | 3-5 |
| CompactFlash (CF) Card | 3-6 |
| USB Flash Memory | 3-6 |

General Information

The printers have the following options available to satisfy your printing requirements.



Note Install the memory module before installing the optional paper feeder (PF-100).

For instructions on installing individual options, refer to the documentation included with the option. Some options are explained in the following sections.

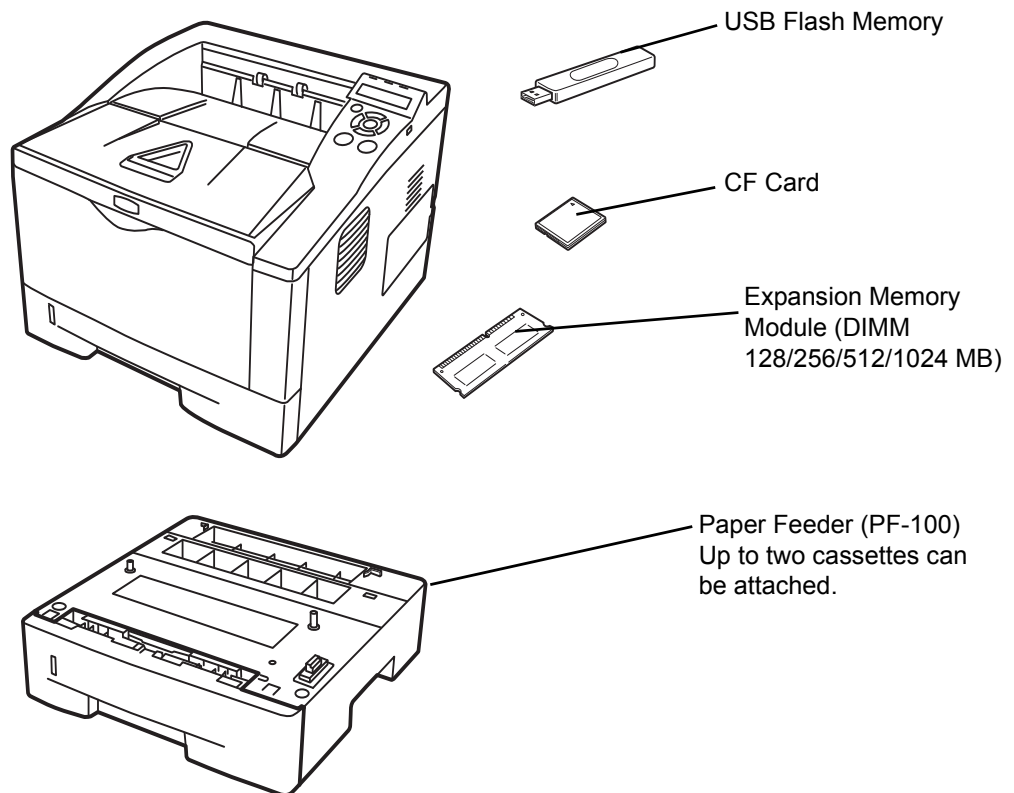

Expansion Memory Modules

To expand the printer memory for more complex print jobs and faster print speed, you can plug in optional memory module (dual in line memory module) in the memory slot provided on the printer main controller board. You can select additional memory module from 128, 256, 512, or 1024 MB. The maximum memory size is 1152 MB.



Note The expansion memory should only be installed by your service technician. We shall not be liable for any damages caused by improper installation of expansion memory.

Precautions for Handling the Printer's Main Controller Board and Memory Module

To protect electronic parts, discharge static electricity from your body by touching a water pipe (faucet) or other large metal object before handling the memory module. Or, wear an antistatic wrist strap, if possible, when you install the memory module.

Always hold the main controller board or a memory module by its edges as shown below to avoid damaging electronic parts.

Correct

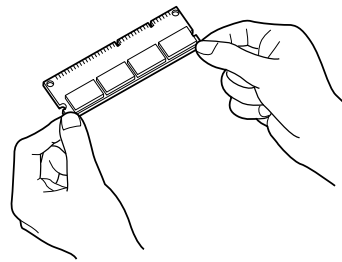

Incorrect

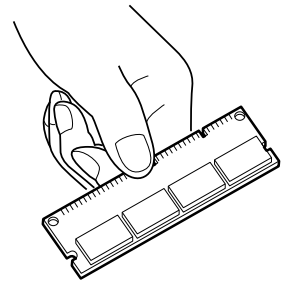

Installing the Memory Module

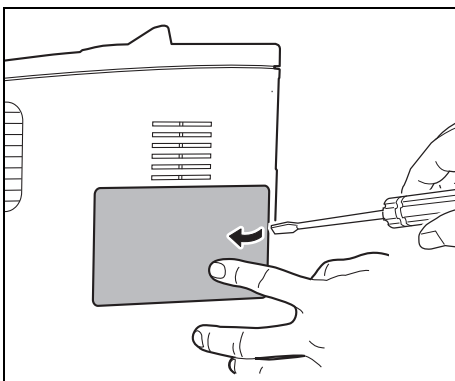

- 1 Turn off the printer and disconnect the power cord and printer cable.
- 2 Remove the right cover as shown in the figure.

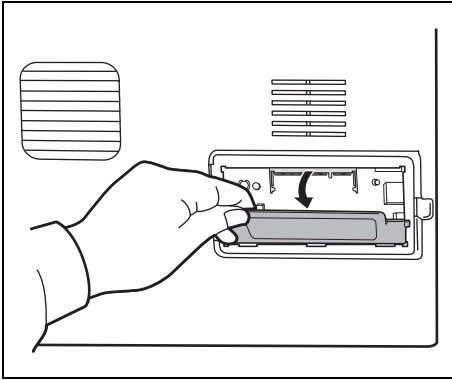

- 3 Remove the fixing tape in case of the first installation. Then, remove the memory slot cover as shown in the figure.

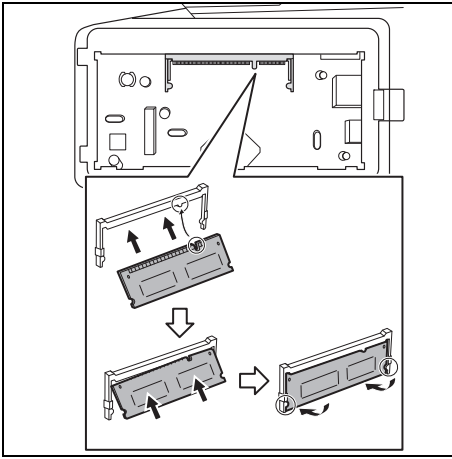

- 4 Remove the memory module from its package.
- 5 Aligning the cutouts of the memory module with the matching keys of the socket, carefully plug the memory module into the memory socket until it clicks in place. Then, push down the memory module to secure.



CAUTION Before inserting a memory module in the printer, make sure that the printer is switched off.

- 6 Push down the memory module to secure.
- 7 Reinstall the memory slot cover and the right cover.

Removing a Memory Module

To remove a memory module, remove the right cover and the memory slot cover from the printer. Then, carefully push out the two socket clamps. Ease the memory module out of the socket to remove.

Verifying the expanded memory

To verify that the memory module is working properly, test it by printing a status page.

Paper Feeder (PF-100)

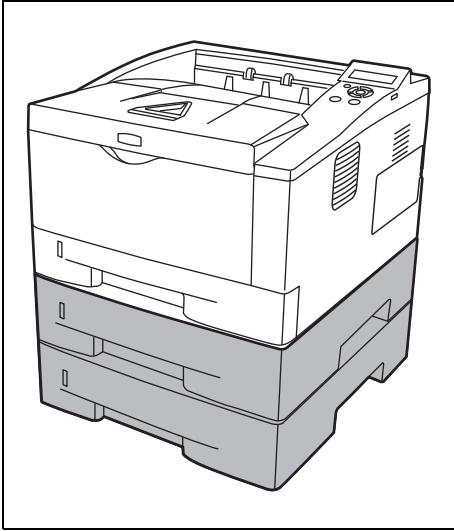

The PF-100 allows you to add two more paper cassette to the bottom of the printer for continuous feeding of a large volume of paper. Each paper cassette can hold up to approximately 250 sheets of ISO A4, ISO A5, JIS B5, Letter, or Legal size (80g/m²) paper. This feeder is attached at the bottom of the printer as shown on the left.



CAUTION Before attaching the PF-100 to the printer, make sure that the printer is switched off.

CompactFlash (CF) Card

The printer is equipped with a slot for a CF card with the maximum size of 256MB. A CF card is useful for storing fonts, macros, and overlays.

- 1 Turn off the printer and disconnect the power cord and printer cable.



CAUTION Before inserting a CF card in the printer, make sure that the printer is switched off.

- 2 Open the rear cover.

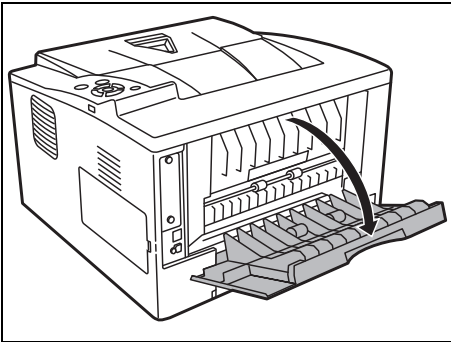

- 3 Remove the screws and the optional interface slot cover.

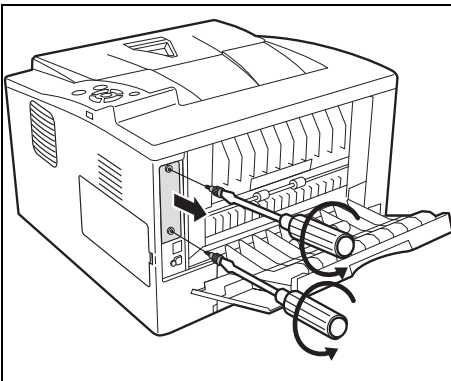

- 4 Insert the CF Card.

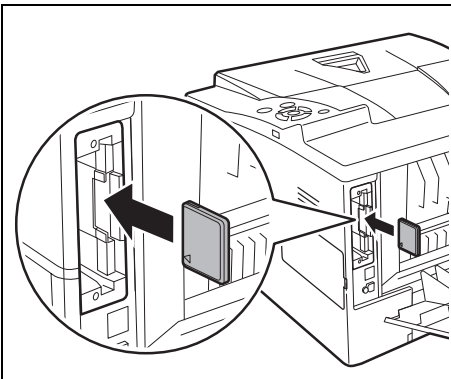

- 5 Secure the optional interface slot cover with the screws removed in step 3.

- 6 Connect the power cord and printer cable and turn on the printer.

USB Flash Memory

See your dealer for purchasing information of this optional device that are best suited for use with this printer.

4 Computer Interface

This chapter contains explanations on the following topics:

| | |
|----------------------------|------------|
| General Information | 4-2 |
| USB Interface | 4-2 |
| Network Interface | 4-3 |

General Information

This chapter explains the connector specifications of USB and network interfaces.

USB Interface

This printer supports the Hi-Speed USB. USB (Universal Serial Bus) interface specifications are as follows.

Specifications

Basic specification

Complies with the Universal Serial Bus Specification Revision 2.0.

Connectors

Printer: B-type receptacle (female) with upstream port

Cable: B-type plug (male)

Cable

Use a shielded cable that complies with USB 2.0 (Hi-Speed USB) and not longer than 5 meters (16 feet).

Transfer Mode

High speed (480 Mbps maximum)

Full-Speed (12 Mbps maximum)

Power Control

Self-power device

Interface Signals

USB Connector Pin Assignment

| Pin | Signal | Description |
|-------|--------|---------------------|
| 1 | Vbus | Power supply (+5 V) |
| 2 | D- | Data transmission |
| 3 | D+ | Data transmission |
| 4 | GND | Signal ground |
| Shell | — | Shield |

Network Interface

Features

Automatic IP address resolution

This feature is compatible with the DHCP/DHCPv6 protocol and allows the printer to automatically receive IP addresses from the DHCP/DHCPv6 server.

Management using Web browsers

HTTP pages are incorporated in to the interface, so that a web browser can be used to monitor and change a range of settings. The settings can be password-protected.

Support for a range of protocols

The SMTP, POP3, SSL, SNMP, IPv6 and NetBIOS over TCP/IP protocols are supported for easier printer management and more robust security.

Support for IEEE 802.1x

The interface supports EAP-TLS and PEAP authentication.

Supports IPv6

Supports IPv6, which is based on IPv4 with improvements, such as increased manageable address space, additional security functions and priority based data transmission.

Supports IPSec

Supports IPSec, the security protocol that authenticates and encrypts in the network layer (IP layer).

Specifications

Connector

10 Base-T/100 Base-TX

Operating Systems

Windows 2000/XP/Vista/Server2003, MacOS 10.x

Network protocols

- IPv6: HTTP, LPD, FTP, IPP, RawPort, ICMPv6, LLTD, SNTP, DHCPv6, SMTP, POP3, DNS, SNMPv1/v2c/v3, WSD
- IPv4: HTTP, HTTPS, LPD, FTP, IPP, RawPort, ICMP, DHCP, SMTP, POP3, SNTP, DNS, WINS, NetBIOS over TCP/IP, SNMPv1/v2c/v3, Apple Bonjour Compatible, IPPS, LLTD, WSD
- Etc.: IPX/SPX, NetWare (NDS/Bindery), AppleTalk, NetBEUI

Security Protocols

SSL/TLS (HTTPS, IPPS), SNMPv3, EAP-TLS, PEAP, AH, ESP

Operation Environment

10 to 35 °C (50 to 95 °F), 20-80% RH (condensation-free)

EMI Countermeasures

VCCI Class B, FCC Class B (U.S.), CE (Europe)

IMPORTANT When IPv6 functions are used, the devices used on the network (routers, PCs, etc) must support IPv6.

Glossary

Additional memory

An additional memory (optional) is used for increasing the memory capacity of this machine. For DIMM that can be used in this machine, contact your service technician.

AppleTalk

AppleTalk offers file sharing and printer sharing and it also enables you to utilize application software that is on another computer on the same AppleTalk network.

Default Gateway

This indicates the device, such as a computer or router, that serves as the entrance/exit (gateway) for accessing computers outside of the network that you are on. When no specific gateway is designated for a destination IP address, data is sent to the host that is designated as the Default Gateway.

DHCP (Dynamic Host Configuration Protocol)

This is a protocol that automatically resolves the IP address, Subnet Mask and Gateway address on a TCP/IP network. Use of DHCP minimizes the load of network administration, especially on network environments with a large number of client computers where it is not specifically necessary to assign a separate IP address to each client, including printers.

dpi (dots per inch)

This indicates the number of dots printed per inch (25.4 mm) as a unit for expressing resolution.

EcoPrint

This is a printing mode that reduces toner consumption. Pages printed in the EcoPrint mode are lighter than pages printed in the normal mode.

Emulation

This refers to emulation of other manufacturers' printers. The printer emulates operation of the following printers: PCL 6, KPDLE, KPDLE (AUTO), Line Printer, IBM Proprinter, DIABLO 630 and EPSON LQ-850.

Form Feed Timeout

While data is being sent to a printer, some pauses may occur. At this time, the printer waits for the next data without making a page break. Form feed timeout is a function to wait only a preset amount of time before it executes an automatic page break. After the waiting period begins, once the designated amount of time is exceeded, the printer will automatically process the currently received data and print it out. If the machine has received no print data for the last page, the printer ends processing of that job without outputting paper.

IP Address (Internet Protocol Address)

The Internet Protocol address is a unique number that represents a specific computer in a network. The format of an IP Address is four numbers separated by dots, e.g. 192.168.110.171. Each number should be a decimal between 0 and 255.

KPDL

KPDL is Kyocera's implementation of the PostScript page description language Level3.

MP Tray

This tray is used instead of the cassette when printing on envelopes, postcards, transparency sheets, and labels.

NetBEUI (NetBIOS Extended User Interface)

An enhanced version of the NetBIOS protocol, it enables the utilization of more advanced functions on small-scale networks than do other protocols such as TCP/IP, etc.

Outline font

With outline fonts, character outlines are represented with numerical expressions and fonts can be enlarged or reduced in different ways by changing the numeric values of those expressions. Printing remains clear even if you enlarge fonts, since the characters are defined with outlines represented with numerical expressions. You can specify the font size in steps of 0.25 points up to 999.75 points.

PostScript

This is a page description language developed by Adobe Systems, Inc. It enables flexible font functions and highly-functional graphics, allowing higher quality printing.

PPM (prints per minute)

This indicates the number of printouts made in one minute.

Printer driver

The printer driver makes it possible for you to print data created using application software. The printer driver for the printer is contained on the CD-ROM supplied with the printer. Install the printer driver on the computer connected to the printer.

Sleep mode

This mode is provided to save power. It is activated when the machine is not used for a preset period of time. In this mode, power is reduced to the minimum. The default setting can be changed.

Status page

This lists machine conditions, such as the machine's memory, the total number of prints and paper source settings. You can print the status page from the operation panel.

Subnet Mask

This is a 32-bit numerical value that defines which bits of the IP address specify the network address and which specify the host address.

TCP/IP (Transmission Control Protocol/Internet Protocol)

TCP/IP is a suite of protocols designed to define the way computers and other devices communicate with each other over a network.

USB (Universal Serial Bus)

An interface standard for low to middle speed serial interfaces. This printer supports Hi-Speed USB. The maximum transfer rate is 480 Mbps and the maximum cable length is 5 meters (16 feet).

Index

Numerics

3DES setting
SSL server 2-63

A

Adhesive label 1-8
Administrator ID 2-57, 2-65
 Change 2-66
Administrator Password 2-58, 2-65
 Change 2-66
AES setting
 SSL server 2-63
Alarm (Buzzer) 2-46
Alternative emulation for KPDL 2-32
AppleTalk 2-61
Automatic Cassette Selection 2-29

C

Canceling a Printing Job 2-6
carriage return code 2-38
Cassette
 paper sizes 1-4
Cassette
 basis weight 1-5
 Paper size 2-21
 Paper type 2-24
CF card 3-6
 option 3-2
Changing default font size 2-34
Character pitch 2-34
Code set
 Setting 2-35
Colored paper 1-9
Common device
 selecting or setting 2-45
CompactFlash card 3-2, 3-6
Computer interface 4-1
Conventions in this guide iv
Counter
 Printed pages 2-18
Creating custom paper type 2-25

D

DES setting
 SSL server 2-62
DIMM 3-2
Duplex path
 Setting 2-26
Duplex Printing 2-30
 Binding modes 2-30
 Error detection 2-51

E

Emulation
 on the status page 2-14
 Setting 2-31
Envelope 1-9
Error Detection
 Duplex printing 2-51
 MP Tray Empty 2-51
 Paper mismatch 2-51
 Setting 2-50
Expansion memory module
 option 3-2

F

Features
 Network interface 4-3
Font select
 Selecting default font 2-33

H

HTTPS setting
 SSL server 2-64

I

Installing CF card 3-6
Installing memory module 3-3
Interface block 2-58
Interface signals
 USB interface 4-2
IPP (Internet Printing Protocol) 2-61
IPP over SSL setting
 SSL server 2-63
IPSec (IP Security Protocol) 2-64

K

Keys
 Basic operation 2-6
 Cancel 2-6
 Cursor keys 2-7
 GO 2-6
 MENU 2-6
 OK 2-7
KPDL Errors 2-32

L

Label 1-7
linefeed code 2-38

M

| | |
|---------------------------------|------------|
| Memory | |
| on the status page | 2-14 |
| Memory Card | |
| Using CF card | 2-49 |
| Memory module handling | 3-3 |
| Menu Selection System | 2-8 |
| Message Display | |
| Indicators | 2-5 |
| Status information | 2-4 |
| Message language | 2-45 |
| Mode Selection Menu | 2-8 |
| MP tray | |
| basis weight | 1-5 |
| minimum and maximum paper sizes | 1-3 |
| Paper size | 1-4, 2-20 |
| Paper type | 1-11, 2-20 |

N

| | |
|-------------------|------|
| NetWare | 2-60 |
| Network | |
| Settings | 2-40 |
| TCP/IP (IPv4) | 2-40 |
| TCP/IP (IPv6) | 2-43 |
| Network Interface | 4-3 |
| Number of copies | |
| USB flash memory | 2-17 |

O

| | |
|-------------------------|------|
| Operation Panel | |
| diagram | 2-3 |
| Option | |
| CF card | 3-2 |
| expansion memory module | 3-2 |
| paper feeder | 3-2 |
| Options | 3-2 |
| Override A4/Letter | 2-31 |

P

| | |
|-----------------------------------|------|
| Page Set | |
| Carriage-return | 2-38 |
| Linefeed | 2-38 |
| Number of copies | 2-37 |
| Print area setting for XPS data | 2-39 |
| Print mode setting for TIFF files | 2-39 |
| Print orientation | 2-37 |
| Wide A4 pitch | 2-38 |
| Paper | |
| minimum and maximum sizes | 1-3 |
| Paper cassette | |
| minimum and maximum page sizes | 1-3 |
| paper type | 1-11 |
| Paper feeder | 3-5 |
| option | 3-2 |
| Paper Feed Source | 2-28 |
| Paper settings | 2-19 |
| Paper Type | |

| | |
|----------------------------|------------|
| Custom | 2-25 |
| Paper weight | 1-5 |
| Setting | 2-25 |
| PF-100 | 3-2, 3-5 |
| Postcard | 1-8 |
| Preprinted paper | 1-9 |
| Print | |
| Fonts List | 2-15 |
| Memory Card File List | 2-15 |
| Menu Map | 2-11 |
| Network Status Page | 2-68 |
| RAM Disk File List | 2-15 |
| Status Page | 2-13, 2-68 |
| Test Page | 2-68 |
| Print density | |
| Setting | 2-26 |
| Print file | |
| USB flash memory | 2-16 |
| Printing a list of files | |
| USB flash memory | 2-17 |
| Printing KPDL error report | 2-32 |
| Print Quality | |
| EcoPrint mode | 2-36 |
| KIR mode | 2-35 |
| Resolution | 2-36 |
| Setting | 2-35 |
| Print settings | 2-28 |

R

| | |
|-----------------------------|------|
| RAM Disk | 2-48 |
| Recycled paper | 1-10 |
| Removing memory module | 3-4 |
| Removing USB flash memory | 2-17 |
| Resetting custom paper type | 2-26 |
| Restart Printer | 2-67 |

S

| | |
|-----------------------------------|------|
| Security level | 2-64 |
| Selecting paper feed source | |
| USB flash memory | 2-17 |
| Selecting regular or dark | 2-33 |
| Service (for maintenance) | 2-68 |
| Special paper | 1-7 |
| Specifications | |
| Network interface | 4-3 |
| USB interface | 4-2 |
| SSL (Secure Sockets Layer) Server | 2-62 |
| Status Page Sample | 2-13 |

T

| | |
|-----------------------------|------|
| Timer | |
| Auto error clear | 2-55 |
| Automatic form feed timeout | 2-53 |
| Auto panel reset | 2-55 |
| Auto sleep | 2-56 |
| Error clear time | 2-55 |
| Panel reset | 2-56 |
| Setting | 2-53 |

| | |
|--------------------|------|
| Sleep | 2-54 |
| Transparency | 1-7 |

U

| | |
|---------------------------|------|
| Unit of measurement | 2-23 |
| Selecting | 2-23 |
| USB Interface | 4-2 |
| USB interface | |
| Interface block | 2-59 |
| USB Memory | 2-16 |
| USB memory slot | |
| Interface block | 2-58 |

V

| | |
|---------------------------------|------|
| Verifying expanded memory | 3-4 |
| Viewing counter value | 2-18 |

**QUALITY
CERTIFICATE**

This machine has passed
all quality controls and
final inspection

